

 **BOSS**

# DIGITAL DELAY DE-200

## Owner's Manual

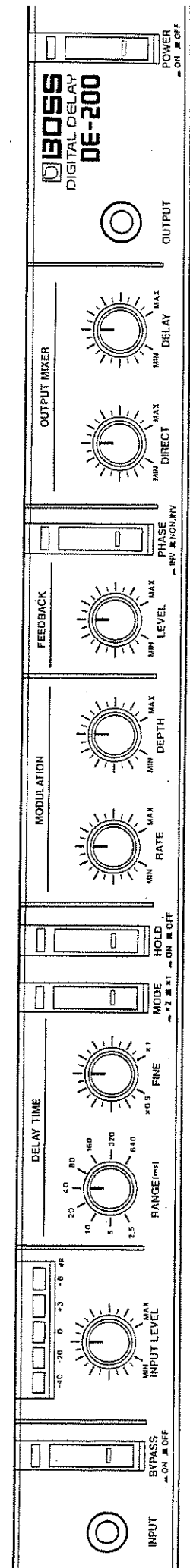

- Analog logarithmic compression and 12 bit quantizing system is adopted to obtain high SN ratio.
- Provided with three output jacks, two kinds of stereo effects are selectable.
- The Rhythm Sync function makes it possible to synchronize the DE-200 with any rhythm machine featuring a trigger out, such as the TR-606, DR-110, etc. Also, it can be used as a sampler.

# DE-200

## Important Notes

- Be sure to use the voltage shown on the Name Plate on the rear panel.
- The DE-200 may generate heat during operation, this is quite a normal situation caused by AC power, so there is nothing to worry about it.
- Please never disassemble the DE-200 even if it breaks down.
- If the DE-200 is not to be used for a long period of time, unplug the cord from the socket.
- Please do not pull the cord but hold the plug when unplugging.
- Please avoid placing or dropping anything heavy on the Power Cable.
- Operating the DE-200 near a neon or fluorescent lamp may cause noise interference. If so, change the angle of the DE-200.
- Avoid using the DE-200 in extreme heat, humidity or where it may be affected by dust.

## Fixing to the 19" Rack

Use 5mm screws

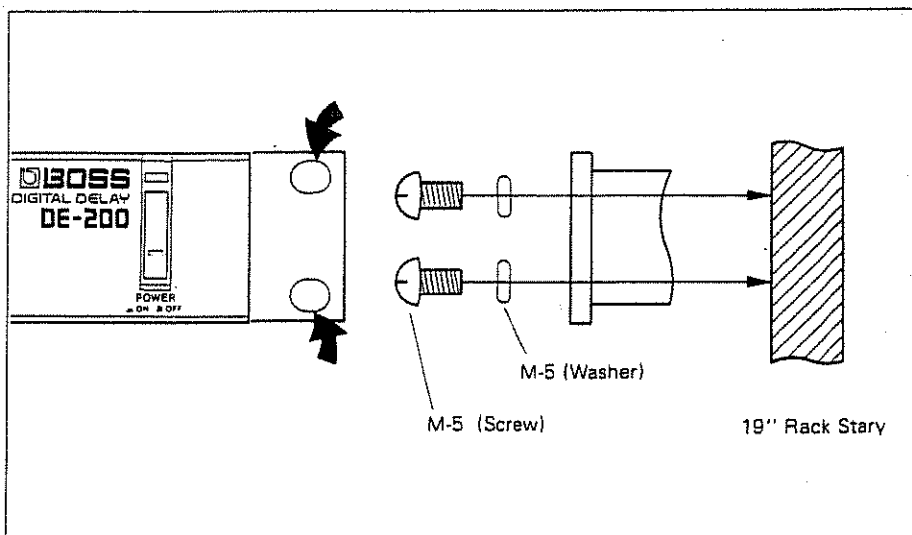

# Control Panel

## Front Panel

### ① Input Jack

Through this jack, signal is fed from an external device such as a musical instrument and mixer.

\* This Input Jack has priority to another input jack on the rear panel.

### ② Bypass Switch with Bypass Indicator

When the DE-200 is turned to the Bypass mode, only direct sound is sent out.

\* This Bypass Switch is not mechanical, therefore does not function when the unit is turned off.

### ③ Input Level Control with the Input Level Indicator

This adjusts the input level.

### ④ Delay Time Range Control

This switch selects any delay time range among 9 options of 2.5 to 640ms.

### ⑤ Delay Time Fine Control

This knob is to delicately change the delay time set with the Delay Time Range Control. It is continuously variable from 0.5 to 1.0 times.

\* By using above two controls ④ and ⑤, it is possible to continuously alter the delay time from 1.25 to 640 ms.

### ⑥ Mode Switch with Mode Indicator

This switch can double the delay time which is set with the Delay Time Range and the Delay Time Fine Controls.

### ⑦ Hold Switch with Hold Indicator

This switch is used to retain the data of panel settings.

### ⑧ Modulation Rate Control

This is to change the LFO frequency for modulation.

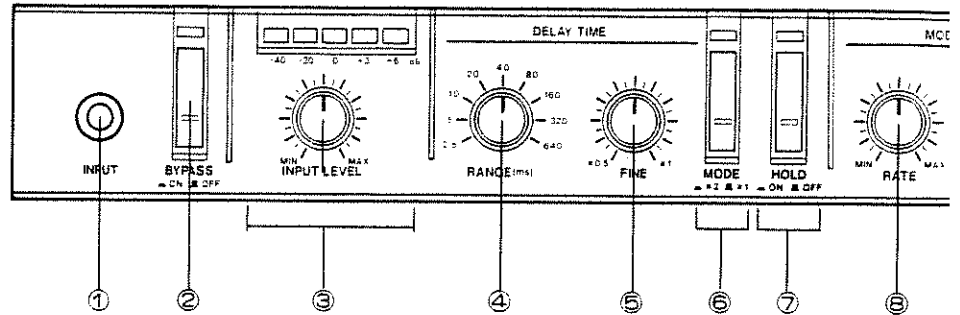

### ⑨ Modulation Depth Control

This sets the depth of the LFO modulation.

### ⑩ Feedback Level Control

This adjusts the feedback level.

### ⑪ Feedback Phase Switch with Feedback-Phase Indicator.

This is to invert the feedback signal.

### ⑫ Direct Output Control

This controls the output level of the direct sounds.

### ⑬ Delay Output Control

This adjusts the output level of the delay sounds.

### ⑭ Output Jack

Through this jack, the mixed signal of the delay and direct comes out.

### ⑮ Power Switch with Power Indicator

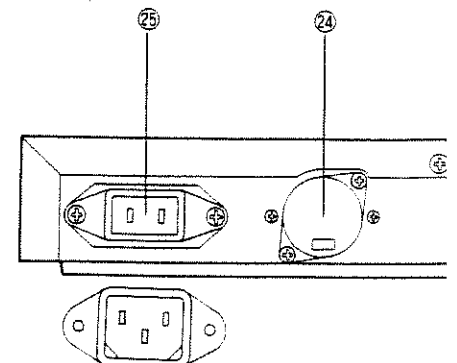

## Rear Panel

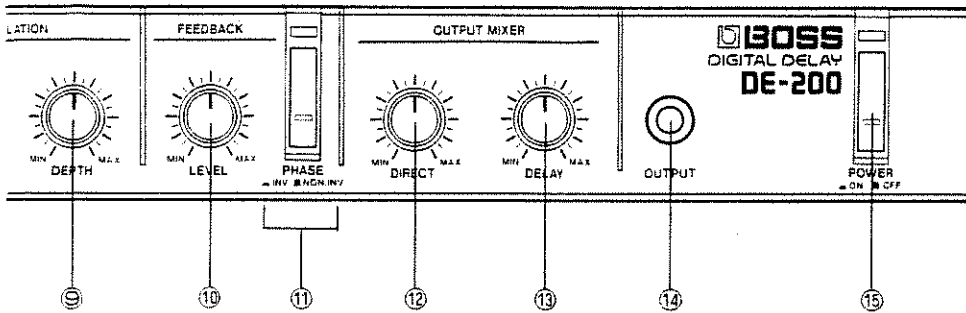

### 16 Input Jack

Through this jack, signal is sent from an external device such as a musical instrument and mixer.

\* The Input Jacks on the front panel has priority to this jack.

### 17 Direct Output Jack

Through this jack, only the direct sound is output.

### 18 Mixed Output Jack

The signal mixed in the OUTPUT MIXER section on the front panel comes out through this jack.

### 19 Inverted Mixed Output Jack

The signal mixed in the OUTPUT MIXER section on the front panel is output through this jack. (Delay signal is inverted.)

### 20 Bypass Remote Jack

This can be connected to the Foot Switch FS-1, thus the DE-200 can be turned to the Bypass or normal mode just by pressing the pedal switch.

### 21 Hold Remote Jack

By connecting the Pedal Switch DP-2 or Foot Switch FS-1 to this jack, the Hold function can be turned on or off with the foot pedal.

### 22 Trigger In Jack.

Through this jack, the signal from the Trigger Out of a rhythm machine can be input.

### 23 Foot Switch Jack

The Pedal Switch DP-2 can be connected to this jack to control trigger signal.

### 24 Voltage Selector Switch (100, 120, 220 or 240V)

### 25 AC Inlet

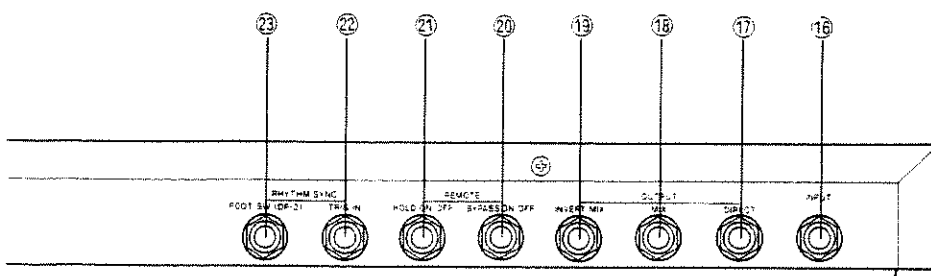

# Operation

- 1** Connect the Echo Send jack of mixer or an instrument to the Input Jack.
  - \* As the DE-200 features rated input level (-20 dBm), it is not possible to input microphone signal directly. So, preamplifier such as the BOSS BX-400 will be required.
  - \* If both Input Jacks on the front and rear panel are used, the one on the front panel will work.

- 5** Adjust the LFO frequency for modulation with the Modulation Rate Control, and its depth with the Depth Control.
  - \* If the Depth Control is set to MAX, the Delay Time set with the Delay Time Range Control will change between 0.5 to 1.0 times.

- 2** Use the Mixed Output Jack for monaural output. To return the signal to the Echo Return of a mixer, use the Mixed Output Jack, and set the Direct Level Control (of the OUTPUT MIXER on the front panel), to MIN (so that only delay sound will be obtained).

- 6** Adjust the feedback level with the Feedback Level Control. If it is set to MIN, single delay effect will be obtained.
  - \* If the Delay Time is set long (echo), the repeat number can be changed, and if it is short (flanger), the resonance can be changed with this same knob.
  - \* With the Feedback Phase Switch, feedback signal can be inverted, therefore the flanger effect will be emphasized.

There are two ways for stereo output

- ① Stereo by Direct and Delay outputs  
Use the Direct Output and Mixed Output jacks, and set the Direct Level Control to MIN.

- 7** Adjust the volume of the direct and the delay sounds by the OUTPUT MIXER section.
  - \* Usually, the Direct Level is to be set to MAX, and only the Delay Level Control is to be changed. (If the DE-200 is set up between the Echo Send and Return of a mixer, or if the stereo effect of 2-① is desired, set the Direct Level Control to MIN. This is to obtain only Delay output.
  - \* Both Output Jacks on the front and rear panel can be simultaneously used.

- ② Stereo by Direct + Delay and Direct + Inverted Delay.  
Use the Mixed Output and Inverted Mixed Output.

- 3** Set the Input Level Control to an appropriate position.
  - \* The Indicator +6 dB is to light up in its peak.
  - \* If the signal exceeding the maximum input level (over +12 dBm) is input, sound distortion may not stop even by reducing the Input Level.

- 4** Set the delay time you like by using the Delay Time Range and the Delay Time Fine Controls. If you use the Mode Switch which can double the set Delay Time, frequency characteristic will become 4.5 kHz/-3 dB.

Mode Switch	Delay Time	Frequency Characteristic
OFF (x1)	1.25ms ~ 640 ms	10Hz ~ 10kHz (+0.5) (-3 dB)
ON (x2)	2.5 ms ~ 1280 ms	10Hz ~ 4.5 kHz (+0.5) (-3 dB)

# Sample Sounds

## Short Echo

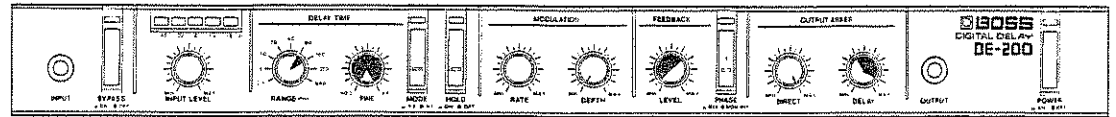

## Long Echo

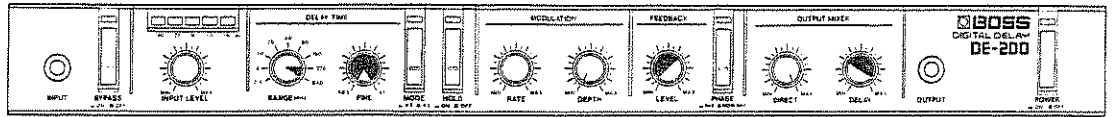

## Deep Echo

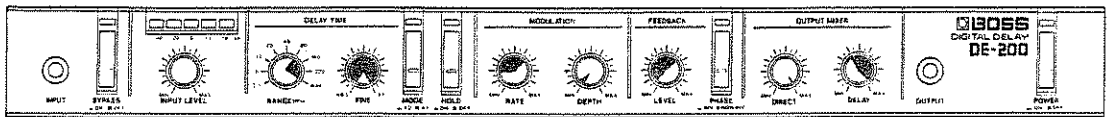

## Doubling

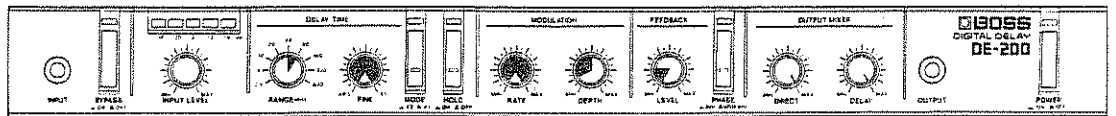

## Chorus

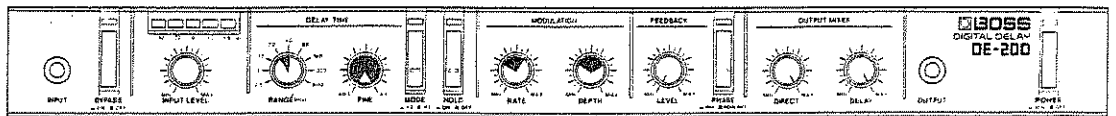

## Flanging

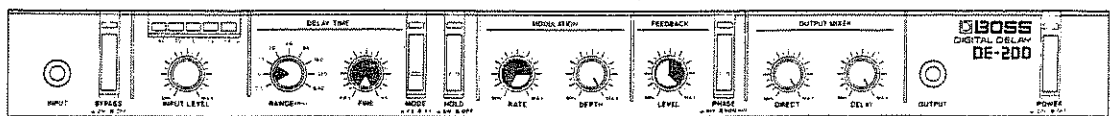

## Fixed Flanging

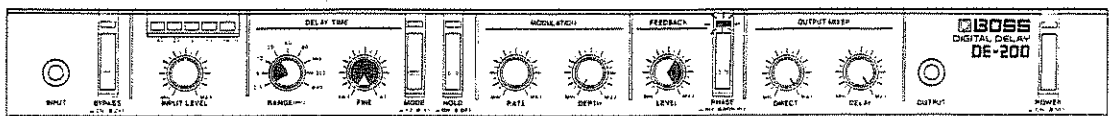

## Sample Note

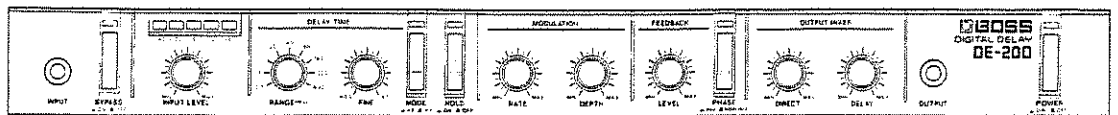

# Application

The DE-200 features a unique function called "Rhythm Sync" that is to start or resume the delay effect by external trigger signal. This enables delay effect finely synchronizing with the rhythm machine you use. Also, by holding the sound you like, it can be used as external sound source for the rhythm machine.

---

## Examples

---

### A Synchronization with a Rhythm machine

You can obtain the Delay effect that finely matches the programmed rhythm.

- ① Connect the Rhythm Sync Jack to the Trigger Out Jack of the rhythm machine. Then the internal system will automatically set the range to MAX (640 ms) regardless of the position of the Delay Time Range Control on the front Panel.
- ② Set the Delay Time Fine Control to MAX (x 1.0).
- ③ If you are to play quick tempo quarter notes or eighth to 16th notes, set the Mode Switch to x 1, and for slow tempo quarter notes or half to whole notes, set it to x 2. Be sure that the trigger cycle does not exceed the maximum delay time.
- ④ If the feedback level is set to MIN, you obtain the single delay that is one note slower than the trigger note set in the rhythm machine. If the feedback level is set to higher, echoes will be repeated at the same timing as the set note. (If it is set to quarter note, echoes will be repeated in quarter note interval, and if set to eighth note, in such an interval.)
- ⑤ Irregular repetition of echo effects can be obtained by setting irregular rhythm in the rhythm machine. Also, if you have written rhythm patterns in a programmable rhythm machine, the echo effect can be automatically varied. (Preset Memory of Delay Time)

### B S. O. S. (sound on sound) play by synchronization with a rhythm machine

- ① Repeat the same procedures as A ① to ③.
  - ② Connect the Pedal Switch DP-2 to the Hold Jack on the DE-200's rear panel. Then the Foot Switch will work as the Hold Switch.
  - ③ Set the Feedback Level Control to MAX. (If you wish to reduce the volume of the previous sound, lower the same control).
  - ④ While pressing the Hold Switch down, start the rhythm machine.
  - ⑤ Releasing the DP-2 will start recording and pressing it will playback the recorded sound. So you can overdub the sounds by pressing or releasing the pedal. The previous sound will remain because of the raised feedback level. If you are to start all over again, set the Feedback to MIN to erase the previous sound.
- \* As you have an aid of a rhythm machine to press the pedal in real time, this operation of S. O. S. playing is far much easier.



**C Using the DE-200 as an external sound source for a rhythm machine.**

- ① Connect a rhythm machine (Trigger Out Jack) and the DP-2 to the Rhythm Sync Jacks of the DE-200.
- ② Set the Delay Time Fine Control and Mode Switch to appropriate position and mode. e.g. for short time recording, set the Mode Switch to "x1" (MAX 640ms). If you like a raised pitch in playback, set the Fine Control to "x1.0" and the Mode Switch to "x2" in recording, and to lower the pitch, set the Fine Control to "x0.5" and the Mode Switch to "x1" in recording. (That is, you can move an octave up or down by changing the Mode Switch.)
- ③ Set the Feedback Level Control to MIN if recording just once, and set to MAX for overdubbing.
- ④ During sampling (recording), stop the rhythm machine. The Foot Switch serves as a recording start switch, so press the pedal to the sound to be recorded in a right timing. (If you press it too late, the head of the sound will be missed out, and if too early, silence will be interfered, therefore there will be no rhythm synchronization possible.) Repeat the same procedure for overdubbing.
- ⑤ If recording has been completed, turn on the Hold Switch on the front panel of the DE-200. (Now it is turned to the playback mode.) Pressing the Foot Switch once again will playback the recorded sound. If the recording is proved unsatisfactory, turn the Hold Switch off and start from the beginning.
- ⑥ If the recording is done satisfactory, start the rhythm machine, the recorded sound source will play along with the programmed rhythm pattern.
- ⑦ With the Delay Time Fine Control and the Mode and Modulation Switches, you can alter the pitch and the tone color, and put vibrato effect.

**< Notes for Rhythm Sync >**

- \* Basically, the trigger cycle should be set within the maximum delay time, but if it happens to exceed it, it sounds like the delay time of such length.
- \* Plugging into the Rhythm Sync Jack will automatically turn the DE-200 to the Rhythm Sync mode. Thus, delay effect is not obtained unless trigger signal is input.
- \* In the Rhythm Sync mode, Delay Time Range is automatically set to 640ms, therefore, the Delay Range Switch in the front panel does not work. The Delay Time Fine Control, however, works as usual.
- \* The DE-200 does not adopt Battery Backup but Dynamic Memory, so the sound you have recorded will be retained only while the unit is turned on, but erased on turning it off.

# Frequency Characteristic

Frequency Characteristic in "X1" mode (with the Delay Time Fine Control set to "X0.5")

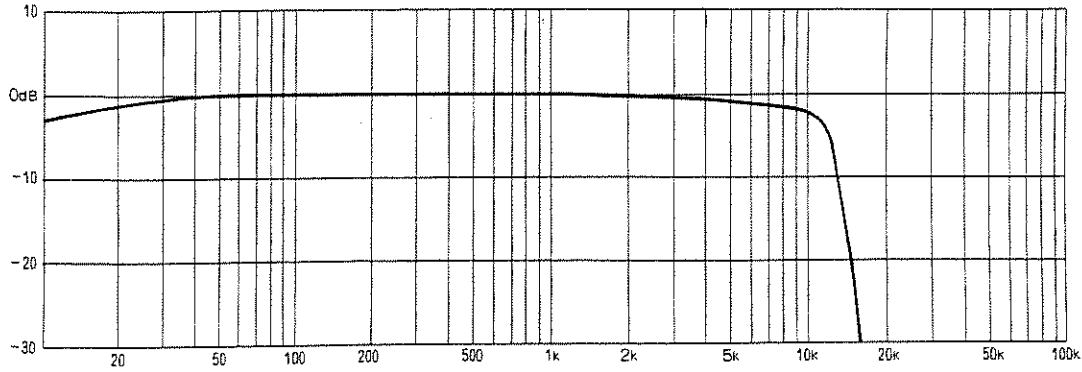

Frequency Characteristic in "X2" mode (with the Delay Time Fine Control set to "X0.5")

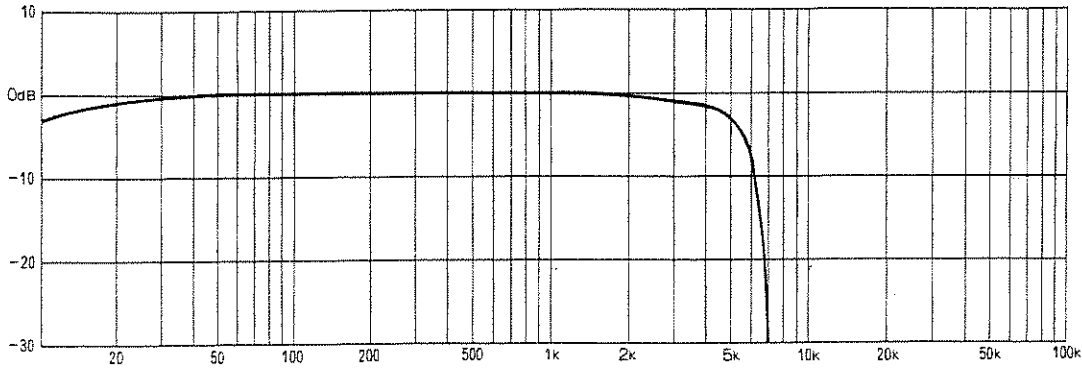

Frequency Characteristic in Bypass mode.

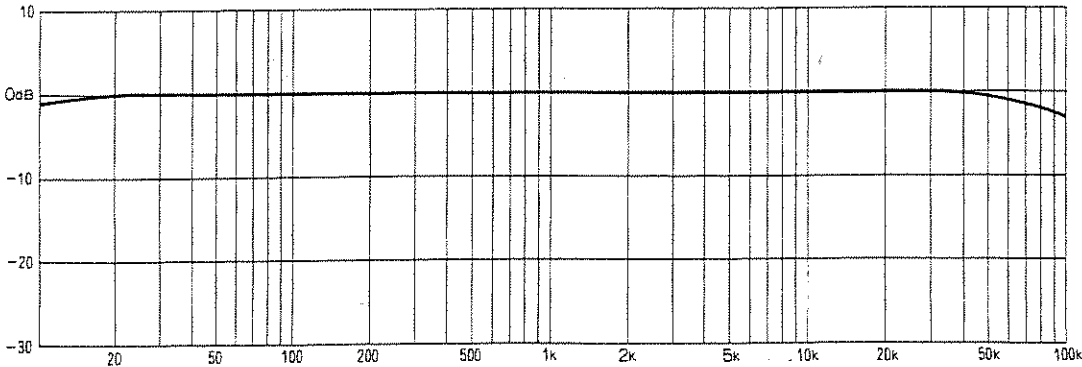

# Block Diagram

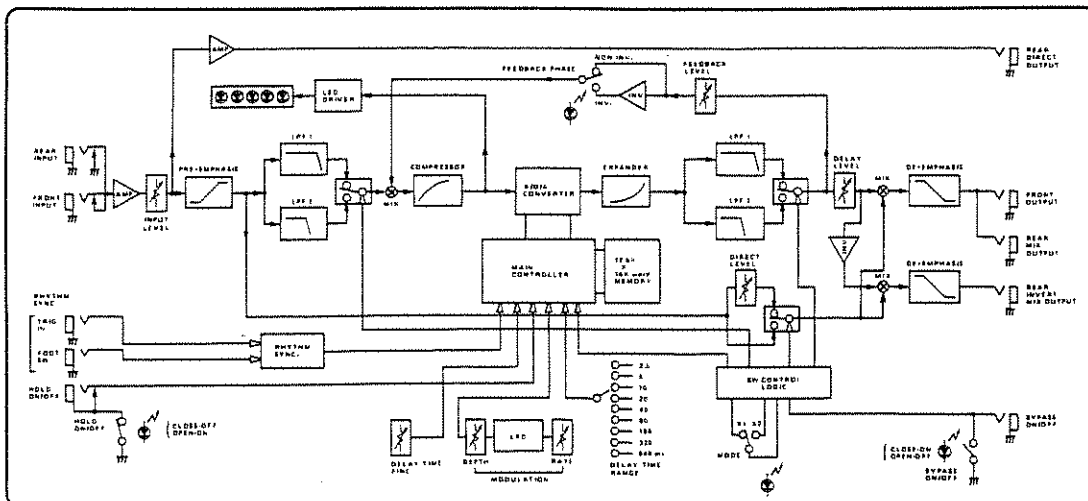

# Specifications

## < Controls >

INPUT LEVEL  
DELAY TIME RANGE (2.5 to 640)  
DELAY TIME FINE (x0.5 to x1.0)  
MODULATION RATE  
MODULATION DEPTH  
FEEDBACK LEVEL  
DIRECT OUTPUT  
DELAY OUTPUT

## < Switches >

BYPASS  
MODE  
HOLD  
FEEDBACK PHASE  
POWER

## < Indicators >

BYPASS  
INPUT LEVEL  
MODE  
HOLD  
FEEDBACK PHASE  
POWER

## < Jacks >

- **Front Panel**  
INPUT  
OUTPUT
- **Rear Panel**  
INPUT  
DIRECT OUTPUT  
MIX OUTPUT  
INVERT MIX OUTPUT  
BYPASS REMOTE (ON/OFF)  
HOLD REMOTE (ON/OFF) RHYTHM SYNC x2

- **Rated Input Level**  
- 20 dBm
- **Maximum Input Level**  
+12 dBm
- **Input Impedance**  
1M $\Omega$
- **Rated Output Level**  
-20 dBm
- **Output Load Impedance**  
10k $\Omega$  or more
- **Dynamic Range**  
110dB (Direct)  
80dB (Delay)
- **Total Harmonic Distortion**  
0.08% (Direct)  
0.25% (Delay)
- **Delay Time**  
1.25 ms to 640 ms (x1)  
2.5 ms to 1280 ms (x2)
- **Frequency Characteristic**  
10Hz to 100kHz +0.5, -3dB(direct)  
10Hz to 10kHz +0.5, -3dB(x1)  
10Hz to 4.5kHz +0.5, -3dB (x2)
- **Power Consumption**  
13 W
- **Dimensions**  
482(W) x 44(H) x 240(D) mm/  
19(W) x 1-3/4(H) x 9-7/16(D) in
- **Weight**  
3.5kg/7lb 11oz

## Options

Foot Switch FS-1  
Pedal Switch DP-2

\*The specifications are subject to change without notice.

**Roland**<sup>®</sup>

**10124**

UPC 10124



10981

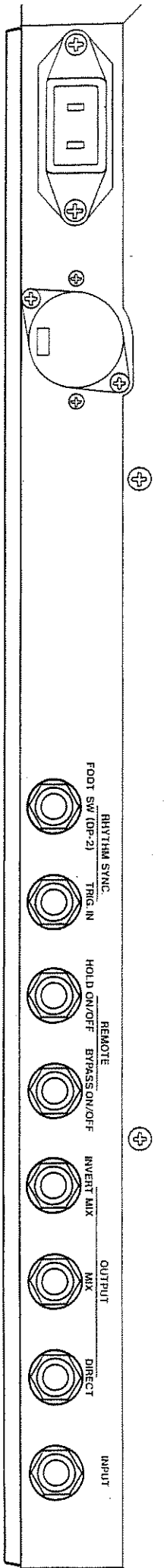

**BOSS**

Products of Roland