

A CPU CLOCK

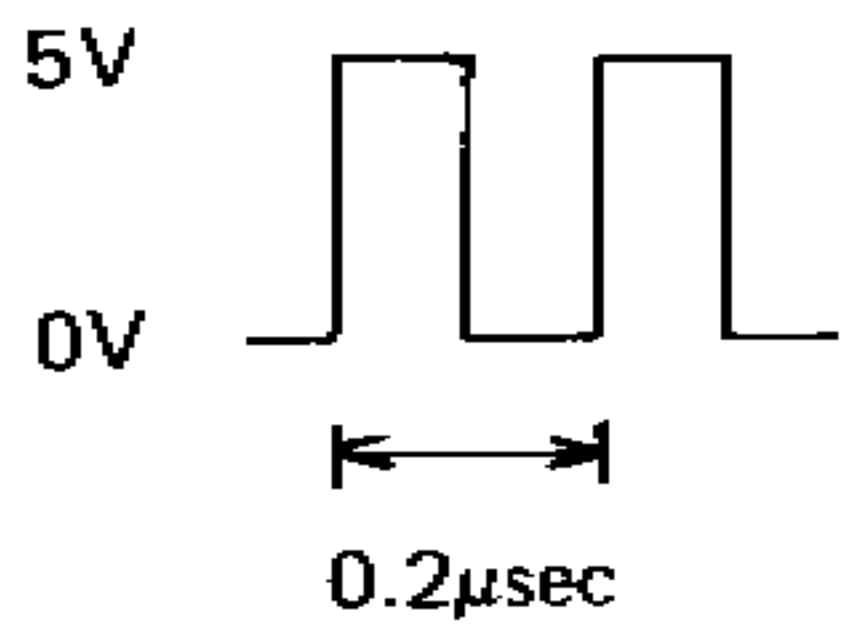

B CPU RESET

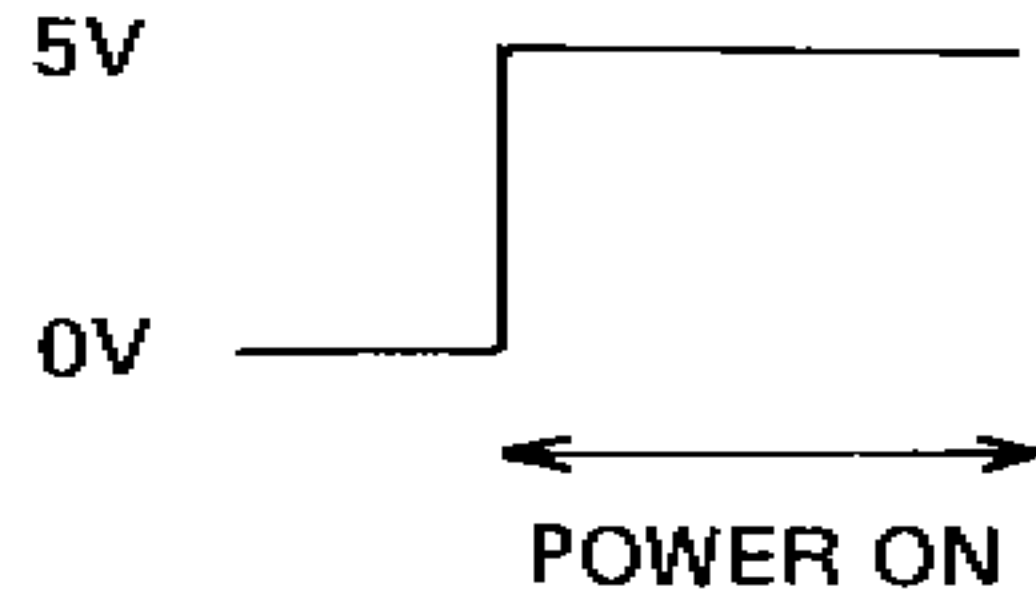

C CPU RES 6.5

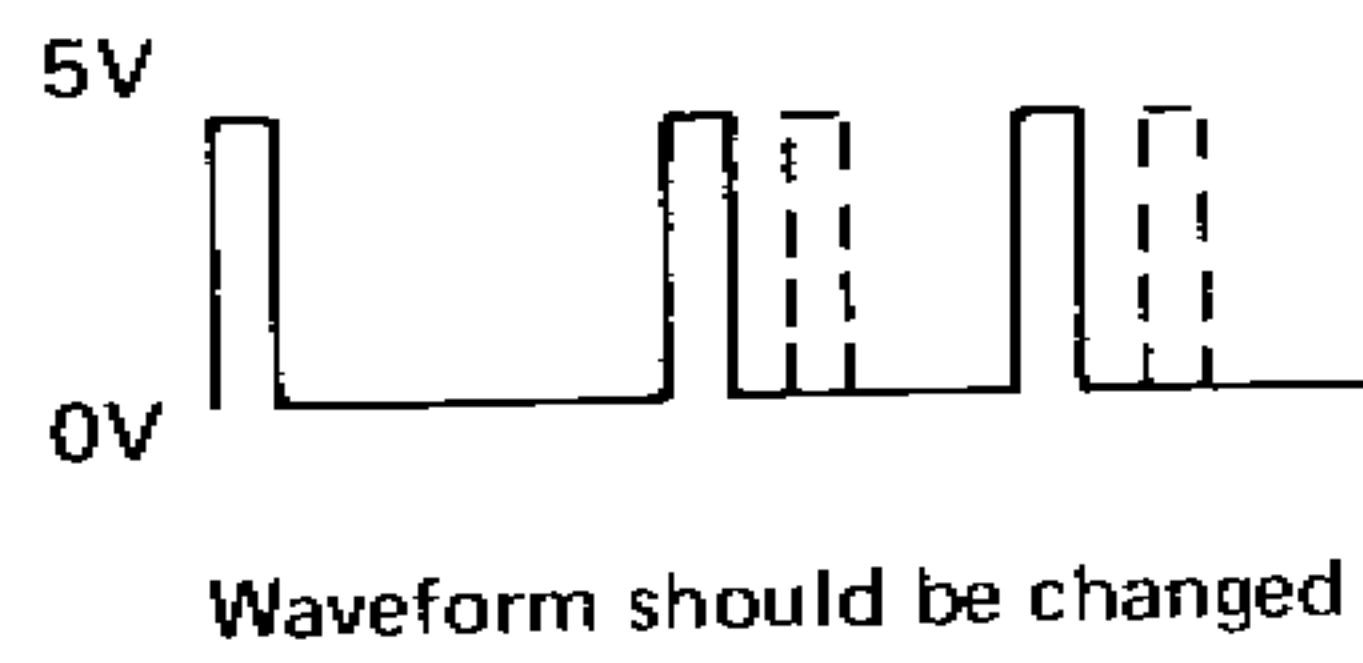

D CPU RES 5.5

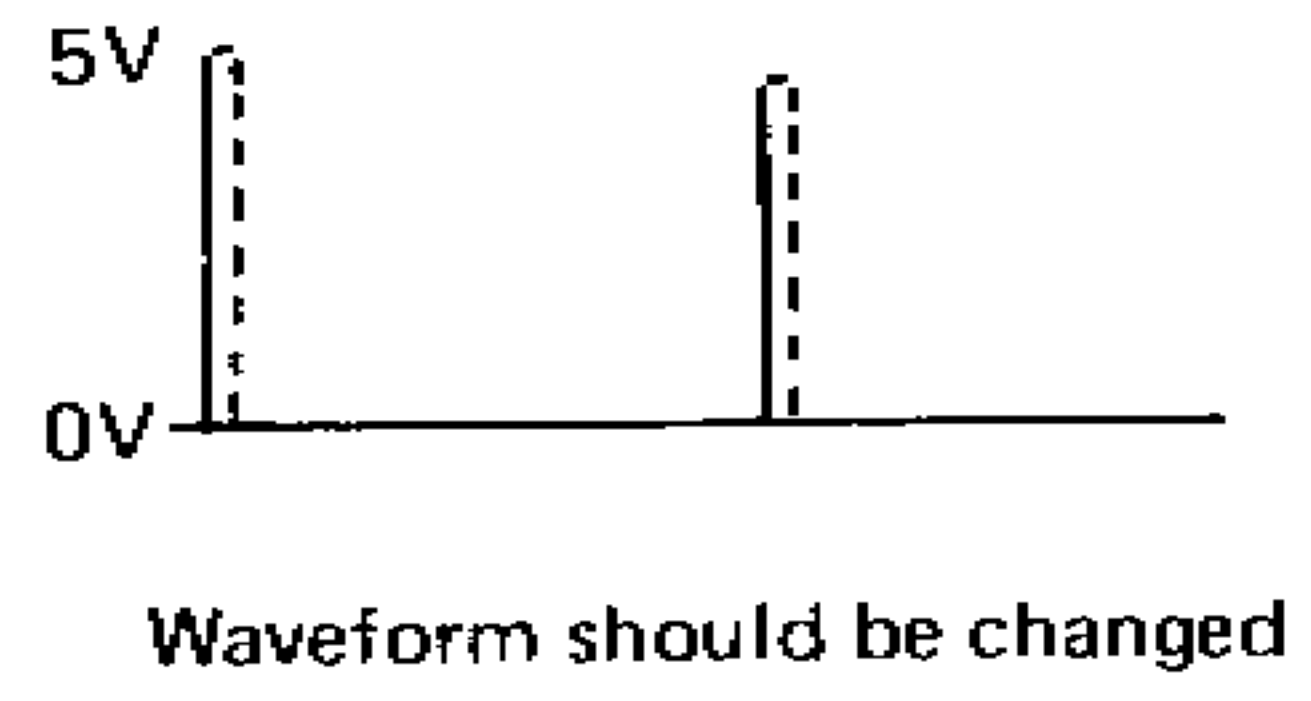

E CPU RES

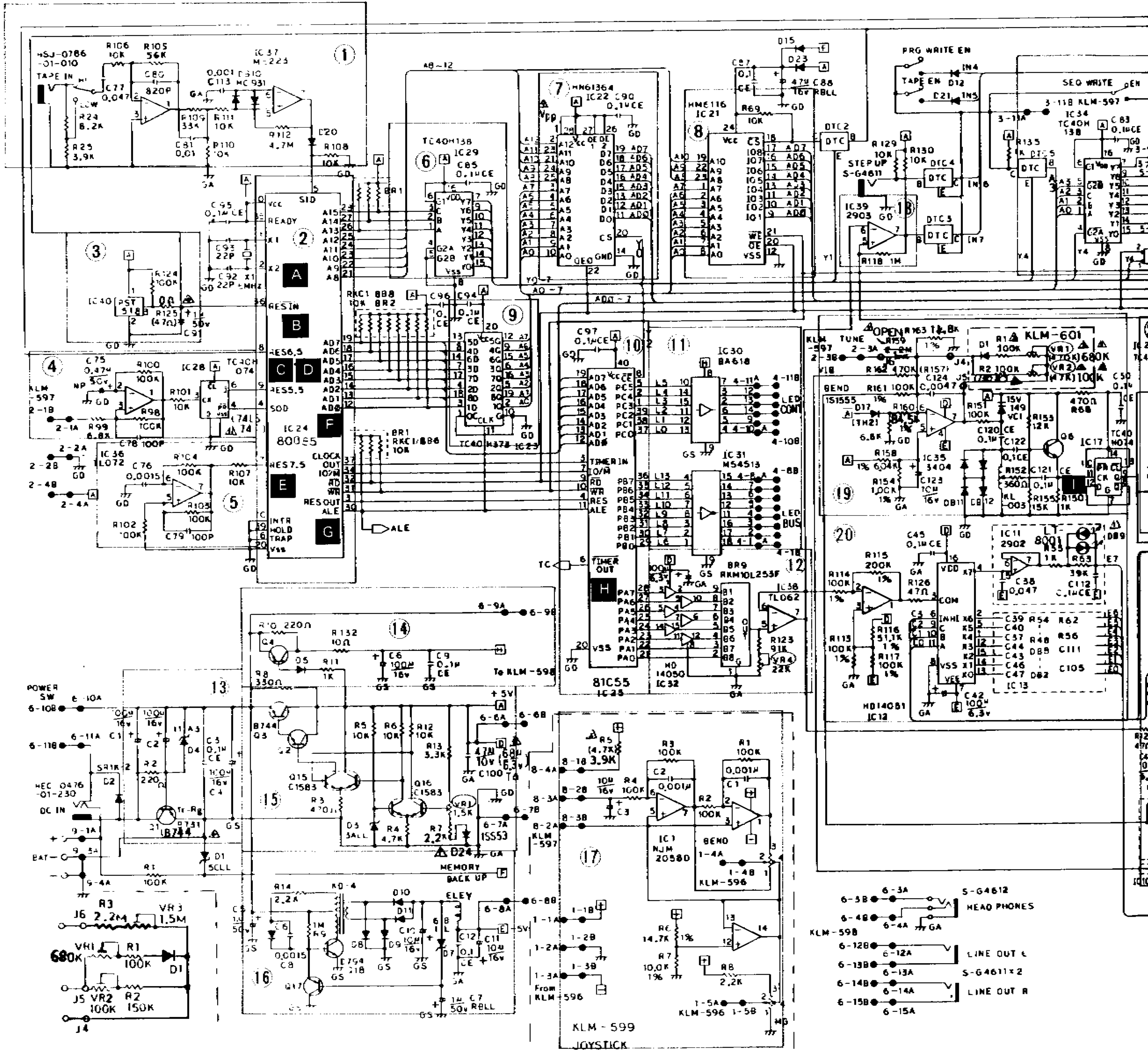
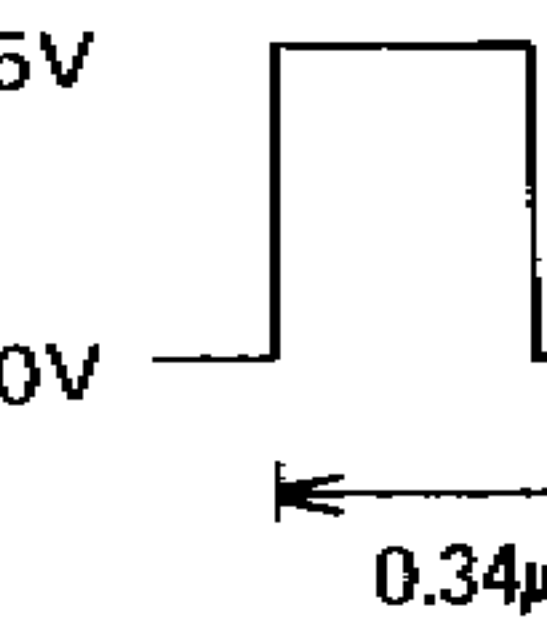

I OSC CLOCK

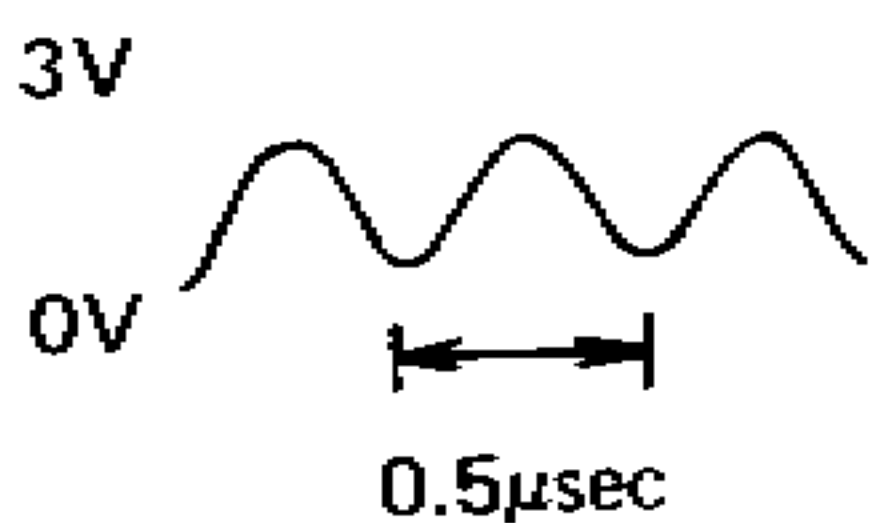

J **K** CLOCK1, 2

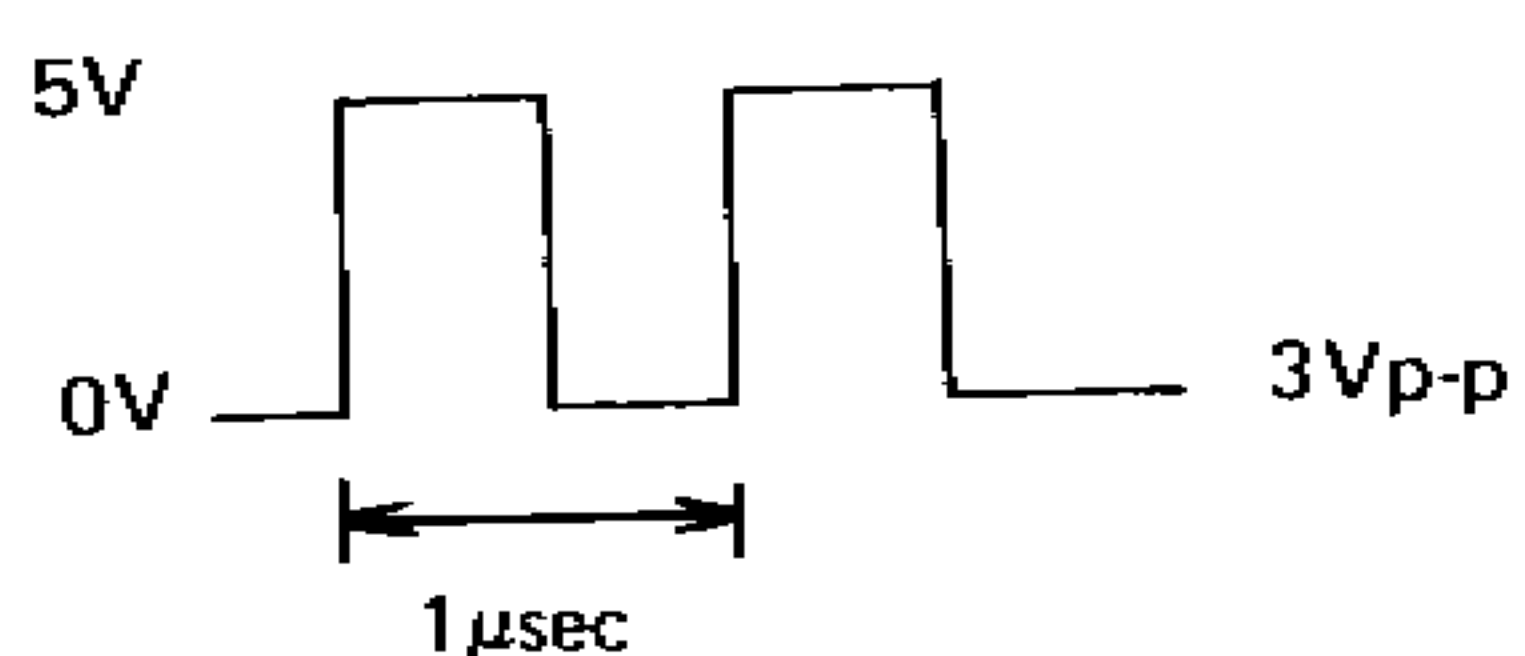

L WHITE NOISE



E CPU RES 7.5

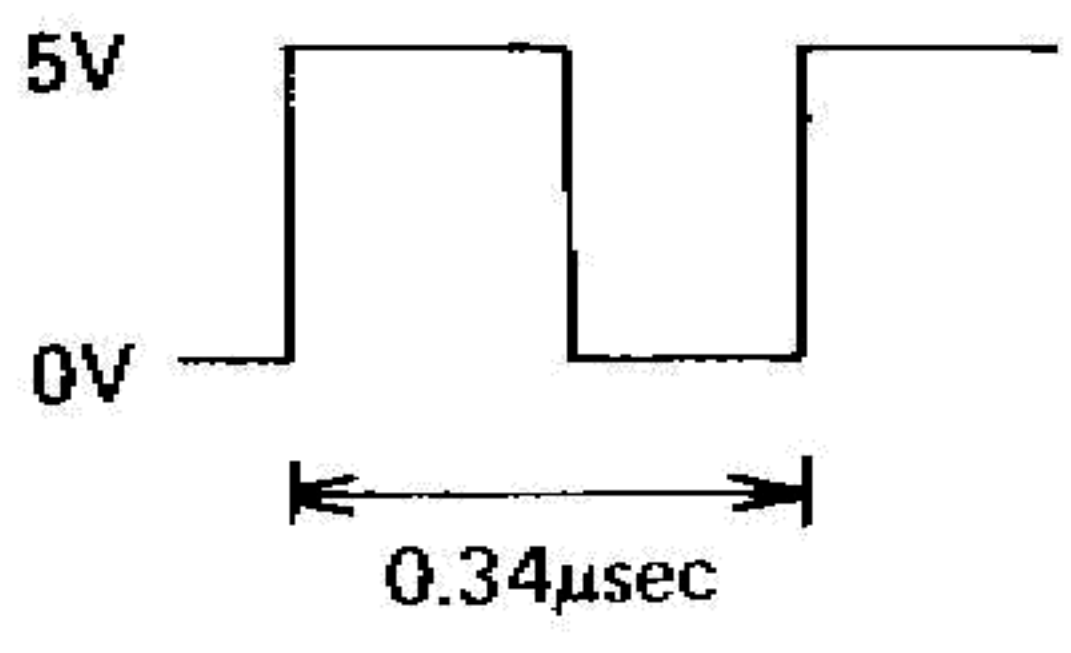

F CPU CLOCK OUT

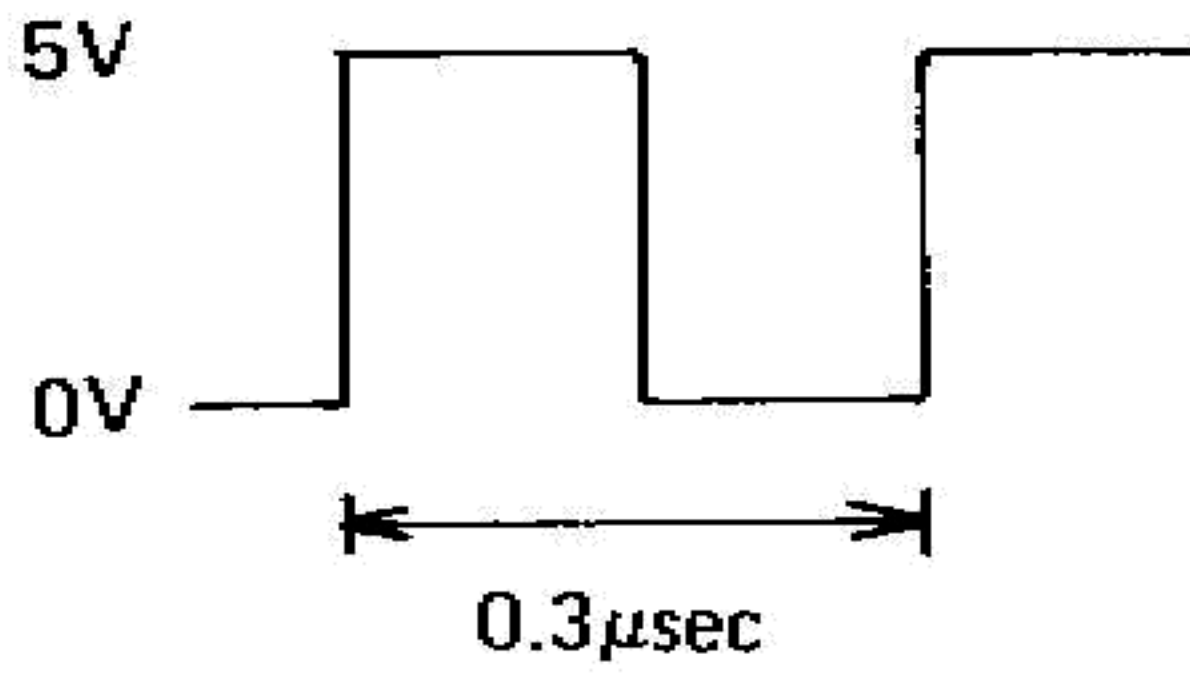

G CPU ALE

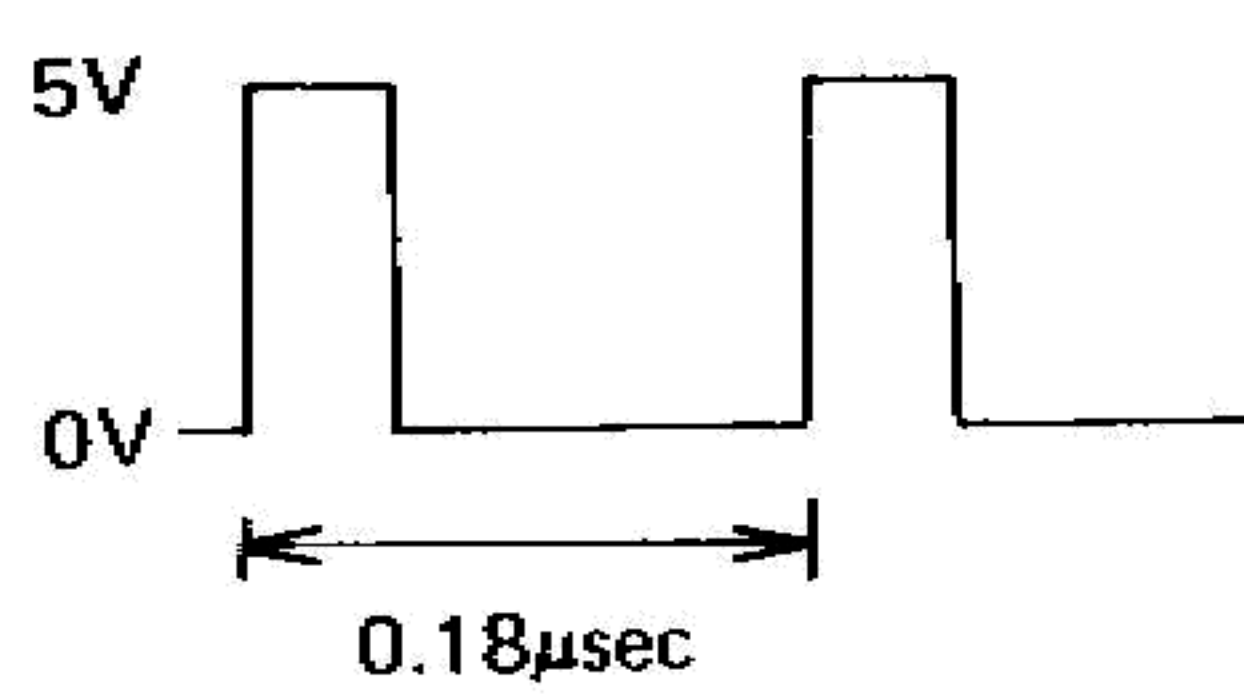

H TIMER OUT

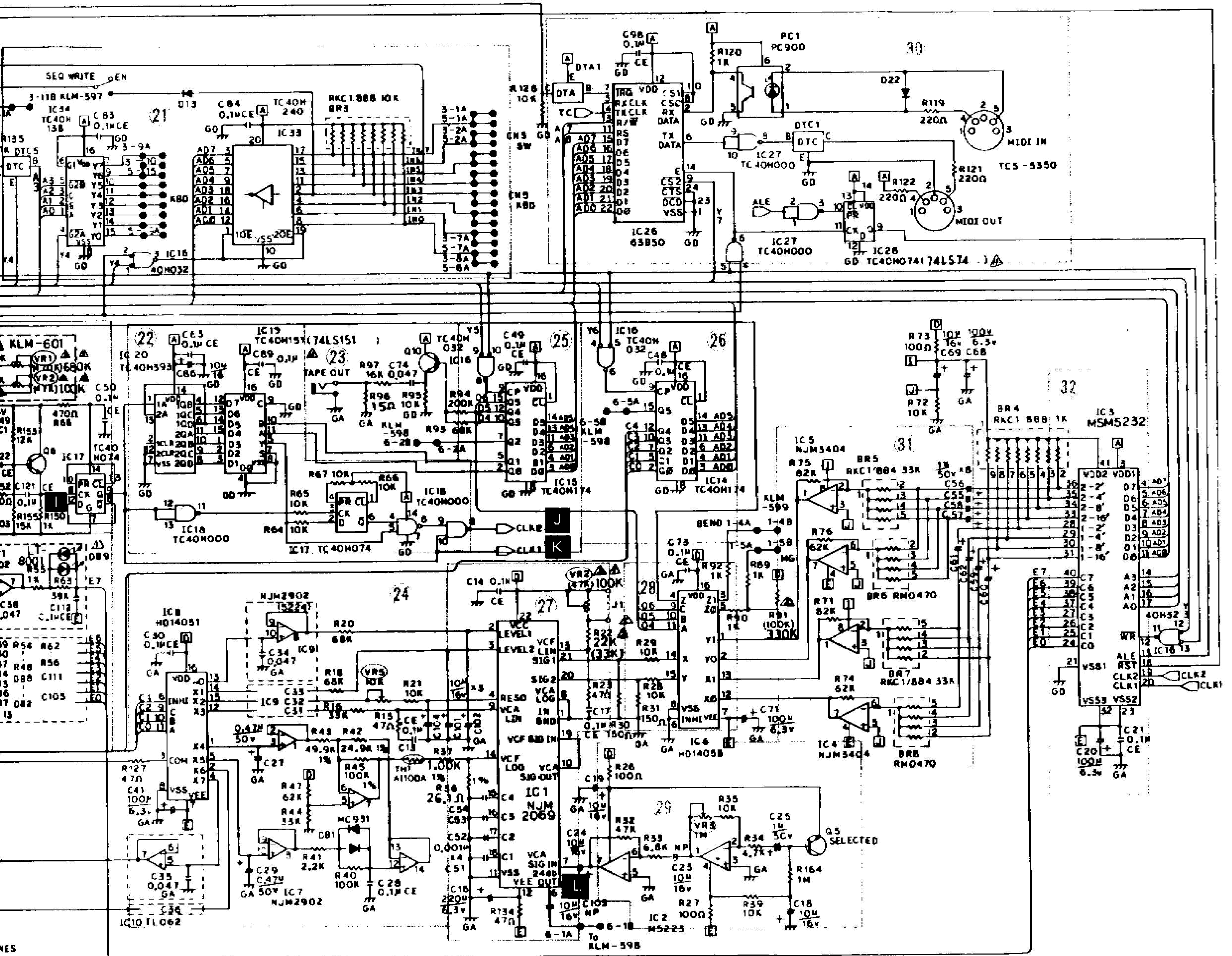
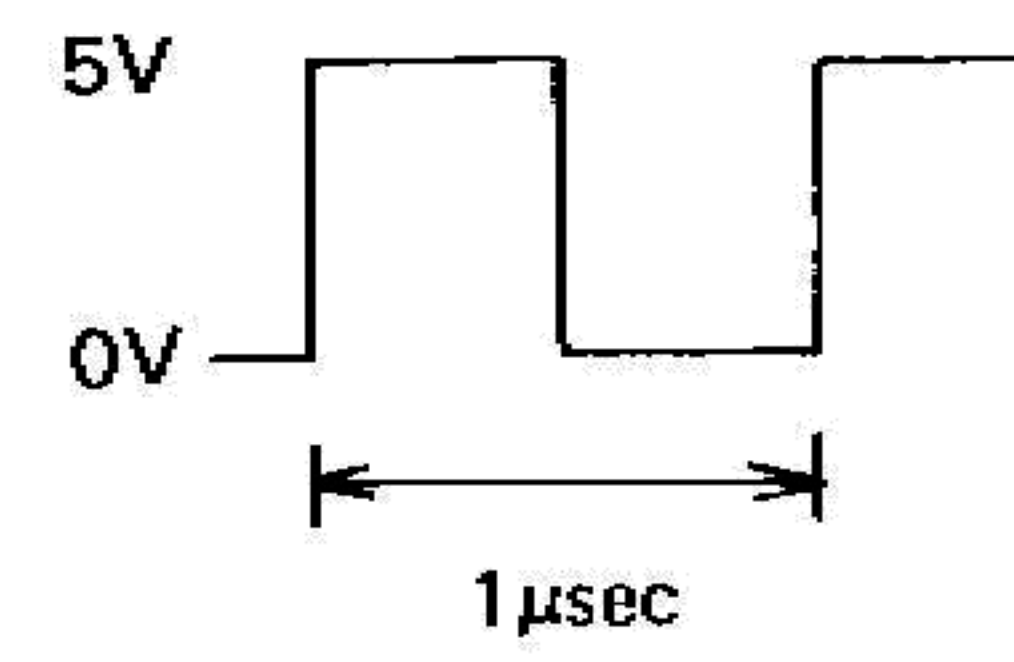

△; MODIFICATION

Value in bracket was used for Old production

IC-8		IC-12	
OUTPUT	FUNCTION	OUTPUT	FUNCTION
X0	DC01 LEVEL	X0	Each EG signal of 8voice is coming out.
X1	DC02 LEVEL	X1	
X2	RESO	X2	
X3		X3	
X4	CUT OFF	X4	
X5	MG	X5	
X6	VIB	X6	
X7	BEND	X7	

4. CIRCUIT DIAGRAM

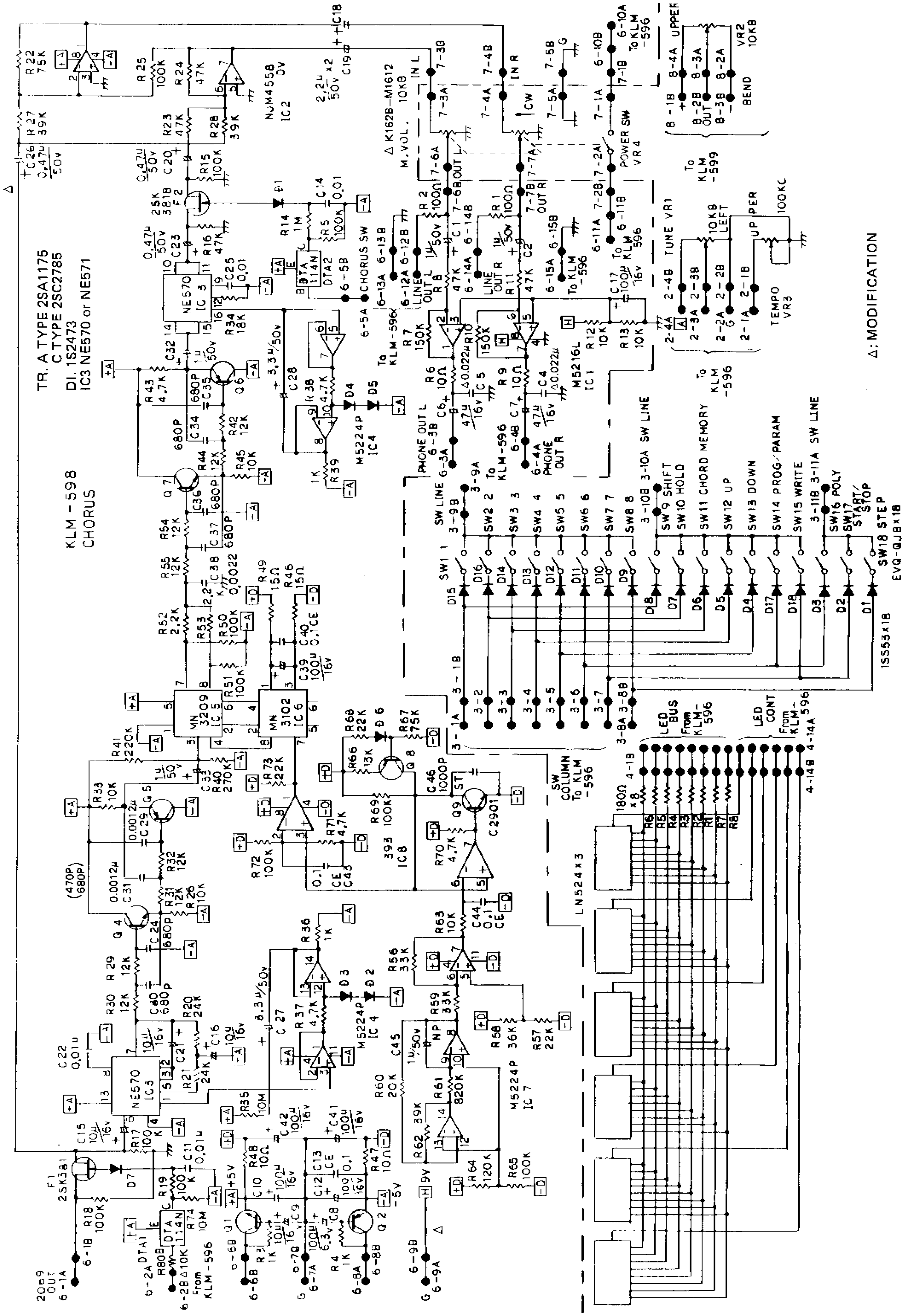

KEY BOARD SWITCH MATRIX (49 Key)

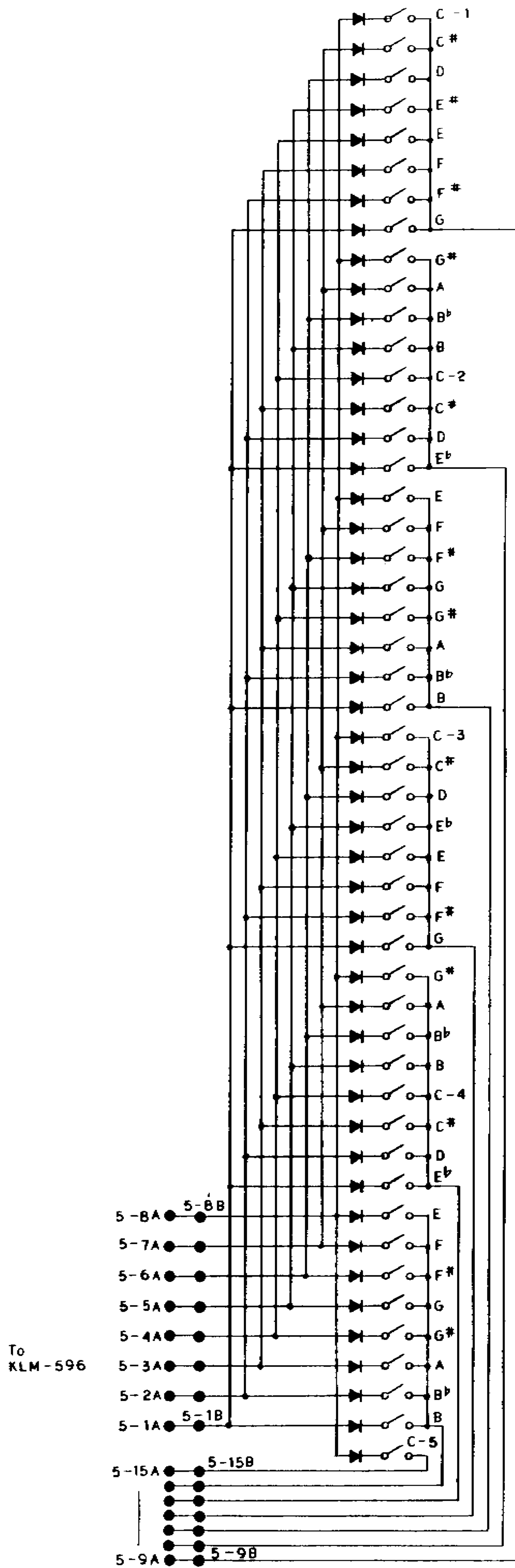

CONNECTOR DIAGRAM

