

Roland
MicroComposer
MC-202

OWNER'S MANUAL

OLDSCHOOL-SOUND

www.oldschool-sound.com

!!!!!!! An exclusive free release !!!!!!!

**SCAN by ::: JC ::: neko201@free.fr ::: PRAJNA rocks !
Free manuals for Free Vintage addicts ! Creative use only**

\$\$\$ Not For Resale \$\$\$

(: Le bizness de ressources est un sport de ptizisis :)

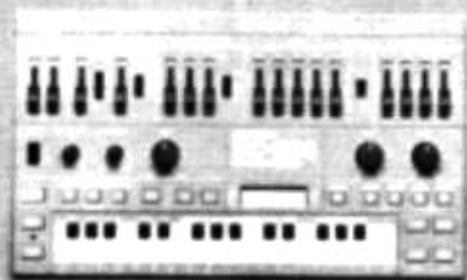

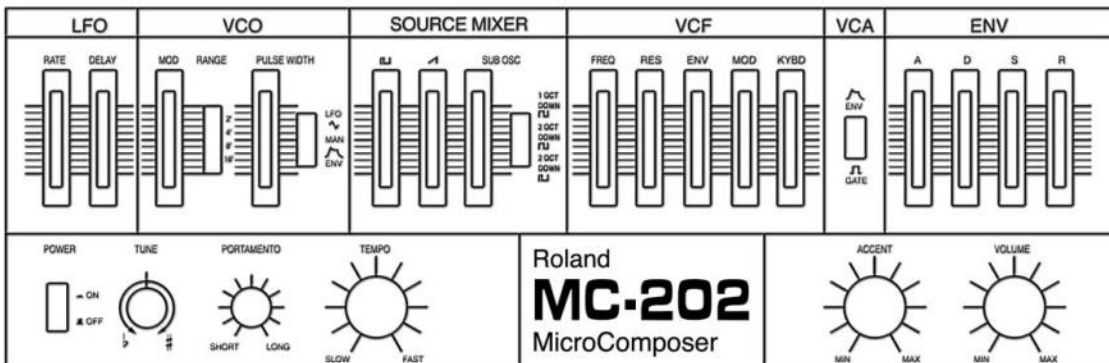
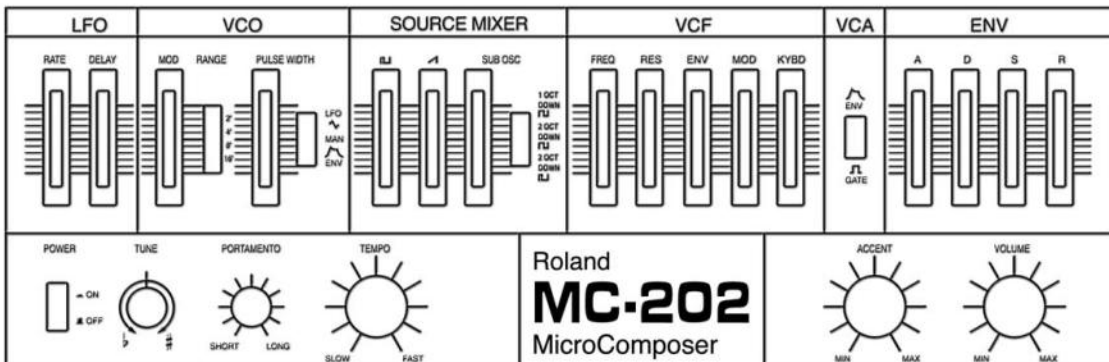
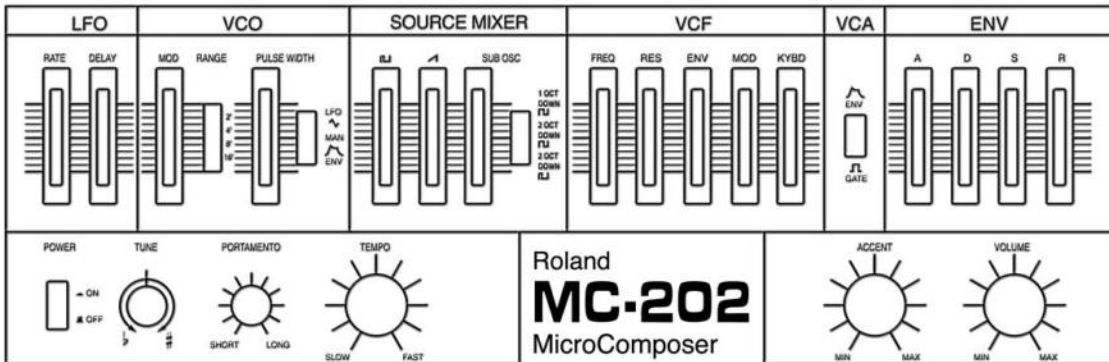

FEATURES

The MC-202 is a 2 channel microcomposer incorporating a monophonic synthesizer.

Microcomposer section

You can spontaneously enter music data just by typing the NUMBER keys or STEP keys, or by playing the keyboard along with the metronome.

Attributes such as Accent and Portamento may be entered as a part of the music data.

By setting up another monophonic synthesizer (1V/Oct), you can play 2 voice music.

The built-in Tape Interface enables you to save the entered music data into an ordinary cassette tape.

The MC-202 offers a total memory capacity of 2600 steps (approx. 150 measures with 8 steps in each measure). Also, the display window tells you how many more steps you may enter.

The Liquid Crystal Display (LCD) indicates the current information (data) or tempo, etc.

A beep will be heard if the operation has been correctly done.

Synthesizer section

This is a high quality synthesizer with 1V/Oct system.

This keyboard covers up to 9 octaves by changing the VCO range, SUB OSC and TRANSCOPE.

Provided with an excellent VCF with sharp cutoff slope of 24 dB.

Jacks and others

3 DIN sockets (IN x 1, OUT x 2) are provided on the MC-202 for synchronizing with an external sequencer or rhythm machine that also includes the same DIN jack.

The MC-202 is also provided with a CV and a GATE jacks (IN x 1, OUT x 2) to control the external keyboard (1V/Oct), or to enter the data by an external keyboard.

By using the Tape Sync function, you can record the Synchro signal onto a tape, and later dub a new part by synchronizing the MC-202 with that signal.

The MC-202 is AC and Battery Powered (AC adaptors BOSS PSA-120, 220 or 240 are optional), and the Display Window tells you if the batteries are low.

OLDSCHOOL-SOUND

www.oldschool-sound.com

!!!!!! An exclusive free release !!!!!

SCAN by :: JC :: neko201@free.fr :: PRAJNA rocks !
Free manuals for Free Vintage addicts ! Creative use only

\$\$\$ Not For Resale \$\$\$

(Le bizness de ressources est un sport de ptizis :)

Contents

Important Notes 6

- Power Supply
- Location
- Cleaning
- LCD
- Cautions

- How to replace the batteries
- Others

1 Introduction 8

2 Panel Descriptions and Connections 9

A. Panel Descriptions

B. Connections

3 Entering data (Basic) 11

A. Setting the synthesizer

B. Entering the data with the STEP, GATE and NUMBER keys.

1. Entering the Pitch
 2. Editing the Step Time and the Gate Time
 3. Editing with the STEP keys and GATE keys
 - Entering the dotted notes and dotted rests
 - Entering the rest
 4. Playing
 5. Editing the Step Time with the NUMBER keys
 6. How to return to the first step in the first measure in the Edit mode
 7. Editing the Gate Time with the NUMBER keys
- Example (1)
8. How to enter the Bars

C. Entering the data by playing the keyboard

1. Connections
2. Operation
 - Entering the Music Data other than 4/4 time

D. Entering the Pitch data by playing the keyboard and Rhythm data by tapping

- Entering the Music Data other than 4/4 time

4 Entering data (Advance) 24

A. Entering data into the CH-2 playing it

1. Connections
2. Tuning
3. Checking the Channel, Entering the data and Playing

B. Entering Accent and Portamento

1. Entering Accent and Portamento
2. How to enter Accent and Portamento
3. Assigning the Accent effect

C. Useful Functions (in Entering)

1. Moving the data forward and backward
2. Transpose function

D. How to correct the data you have entered

1. Correcting the Pitch
2. Correcting the Step Time and the Gate Time
 - Using the STEP keys and the GATE keys
 - Editing with the NUMBER keys
3. Deleting and Inserting notes
 - How to delete the notes
 - How to insert the notes

5 Useful functions by bars 35

A. How to set the bars, etc.

1. Measure number display
2. How to forward or back the whole measure
3. How to recall a measure

B. Playing and Editing from the measure you select

1. Playing from the measure you select
2. Editing from the measure you select
 - Editing with the STEP keys and GATE keys
 - Editing by playing the keyboard or tapping
3. How to delete the whole measure
4. Editing the bars
 - Adding bars
 - Deleting bars
 - Moving the bars

C. How to copy the data

6 Other useful functions 41

A. Tempo display

B. Memory Capacity Check	
How to read the Display Window	
Memory Capacity	
C. Step Number Check	
If the Total Step Time is not correct	
D. \uparrow and \downarrow display	
E. Beep sound ON/OFF	

7 Saving the Music Data 44

A. Save, Verify, Load	
B. Setting up	
C. Operation	
1. Save	
2. Verify	
3. Load	
D. The appropriate tape for saving	
Preserving the data tape, etc.	
E. Power Save Function	

8 Applications 49

A. Integrating the set up of the MC-202	
B. Rear Panel	
C. Connecting to a synthesizer	
1. Controlling the MC-202 by the external keyboard	
Connections	
Cautions	
Calibration	

D. Synchronizing with an external device

1. MC-202 + Sequencer
 - MC 202 + MC-4
 - MC-202 + CSQ-600
 - MC-202 + TB-303
2. MC-202 + Rhythm Machine
 - MC-202 + TR-808, 606, CR-8000
3. Multiple set up
4. MC-202 + MC-202

E. Tape Sync (Multi-Track Recording)

- How to set up
- How to record the synchro signal
- How to play the data with the synchro signal (Multi-Track Recording)

Sound Range Diagram	59
In Case of Trouble	60
Specifications	61
Options	63



!!!!!! An exclusive free release !!!!!
 SCAN by ::: JC ::: neko201@free.fr ::: PRAJNA rocks !
 Free manuals for Free Vintage addicts ! Creative use only
 \$\$\$ Not For Resale \$\$\$
 (: Le bizness de ressources est un sport de ptizis :)

IMPORTANT NOTES

Power Supply

The MC-202 adopts AC and Battery Powered system.

Use only the BOSS PSA series (PSA-120, 220 or 240) for AC operation.

Do not turn the POWER switch on before connecting the AC Adaptor to the MC-202.

Location

Operating the MC-202 near a neon or fluorescent lamp may cause noise interference. If so, change the angle of the MC-202.

Avoid using the MC-202 in excessive heat or humidity or where it may be affected by sunlight or dust.

Cleaning

Use a soft cloth and clean only with a neutral detergent. Do not use solvents such as paint thinner.

LCD

View the Display from the proper angle.

Please be careful not to damage the window.

Cautions

The MC-202's Memory is volatile (i.e. the data is not retained if the MC-202 is switched off). Therefore, to avoid accidental erasure of the data, you may be required to save the data (refer to P. 45) before turning the MC-202 off.

Specially when the MC-202 is operated by battery power, take a good notice of the battery consumption. If the Battery indicator on the right side in the Display Window flashes showing that the batteries are getting low, immediately replace them with a new set. Otherwise, the MC-202 stops operating correctly in about 1 hour.

Be sure to save the data on tape before exchanging the batteries.

Even while using the AC Adaptor, be sure to keep the battery securely connected, so that even if the AC adaptor cord comes out during performance, the MC-202 will continue to operate. (If, however, the Adaptor get disconnected from the AC outlet, the data will be erased.)

Normally, battery replacement is required in about 8 hours (varies depending on how the device is being used, and what kind of batteries are used).



How to replace the batteries

Use 6 of 1.5V cells.

- ① Turn the MC-202 off. If using the AC Adaptor, disconnect the cord from the MC-202.



- ② Remove the lid of the Battery housing.

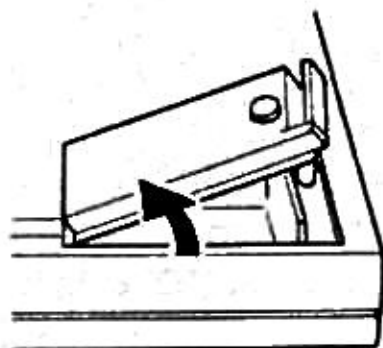

- ③ Take the batteries out of the Battery Housing and replace a new set.

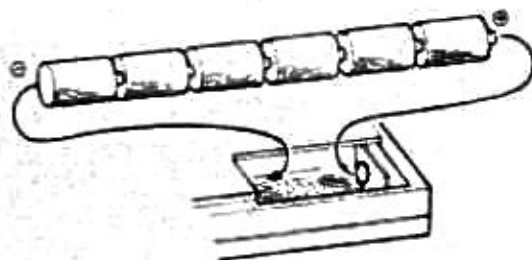

- ④ Replace the lid of the Battery Housing.

Others

- If the MC-202 is not to be used for a long period of time, remove the batteries to prevent problems caused by battery leakage.
- When running the MC-202 by battery power, be sure to turn the power off afterwards.

OLDSCHOOL-SOUND
www.oldschool-sound.com
!!!!!! An exclusive free release !!!!!!

SCAN by :: JC :: neko201@free.fr :: PRAJNA rocks !
Free manuals for Free Vintage addicts ! Creative use only
\$\$\$ Not For Resale \$\$\$
(Le bizness de ressources est un sport de ptizis :)

1 Introduction

The MC-202 is a 2 channel microcomposer incorporated with a monophonic synthesizer. Therefore, by setting another monophonic synthesizer (SH-09, SH-2, SH-101, SYSTEM 100M, etc.), you can enjoy Synthesizer Duet.

There are three methods of entering music data into the MC-202;

① **Typing the STEP, GATE and NUMBER keys (No need to play the keyboard)**

② **Playing the keyboard**

③ **Playing the keyboard for Pitch entry and tapping the TAP key for Rhythm entry**

In the MC-202, we consider that a note includes the following three elements (information).

① **Pitch** (entered by playing the keyboard)

② **Timing Value=Step Time** (entered with the corresponding figures)

③ **Actual Sounded Value=Gate Time** (entered with the corresponding figures)

A note of a certain Step Time lasts longer in legato and shorter in staccato. So the Gate Time is to be set apart from the Step Time.

Refer to the figures shown below.

The MC-202 can be set to either Play or Edit mode. The Play mode turns the built-in synthesizer (or/and the external synthesizer) to playing. In its Edit mode, you can enter the data into the CH-1 and CH-2 separately. If everything is clear so far, please start entering the data.

A

	In Tempo					Viennese waltz		
Step Time	48	48	24	24	48	48	50	46
Gate Time (legato)	46	48	22	22	46	46	48	44
Staccato	10	10	5	5	10	10	11	9

B



Pitch	3C	3D	3E	3F	3G
Step Time	48	48	24	24	48
Gate Time	46	46	22	22	46

2 Panel Descriptions and Connections

A. Panel Descriptions

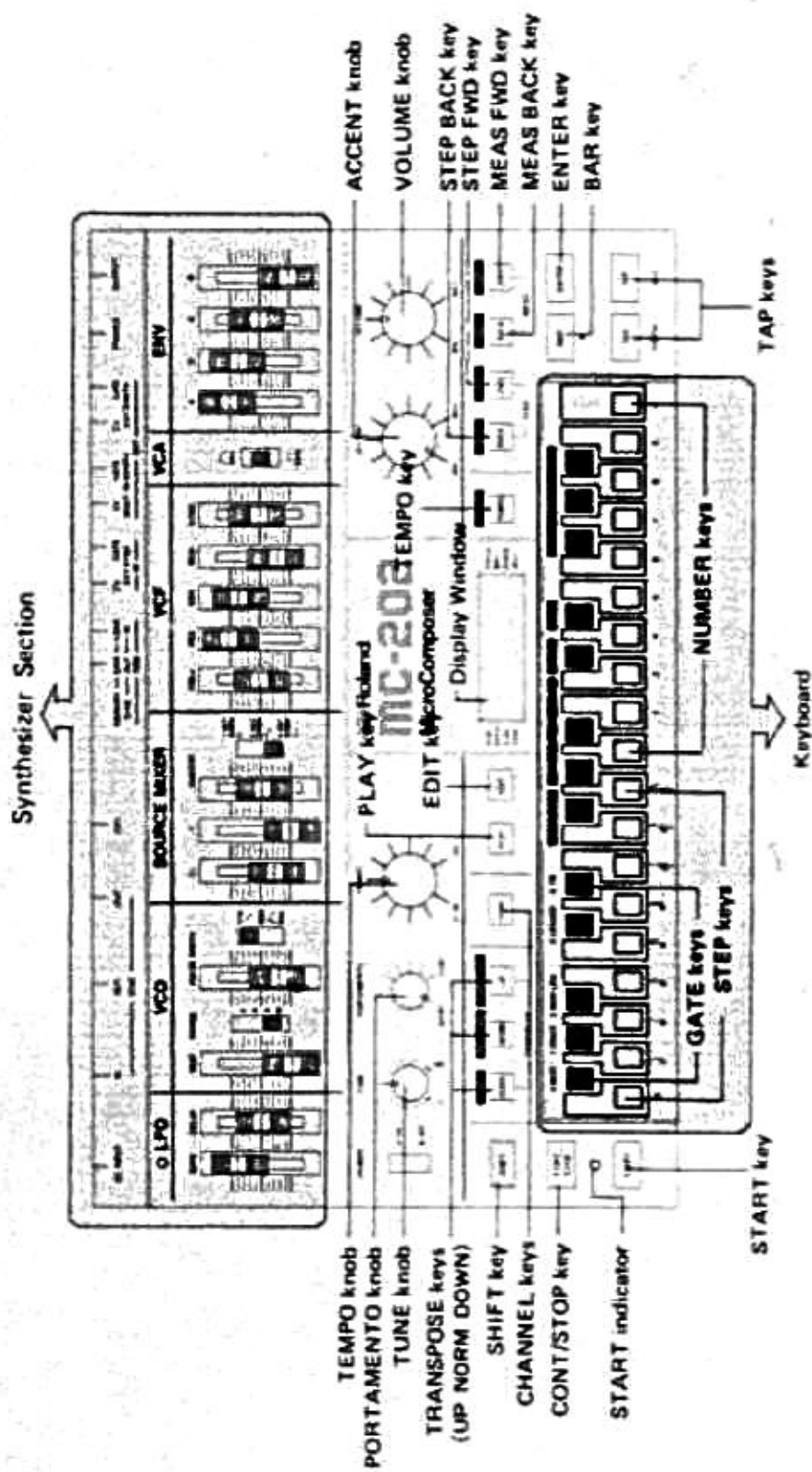

B. Connections

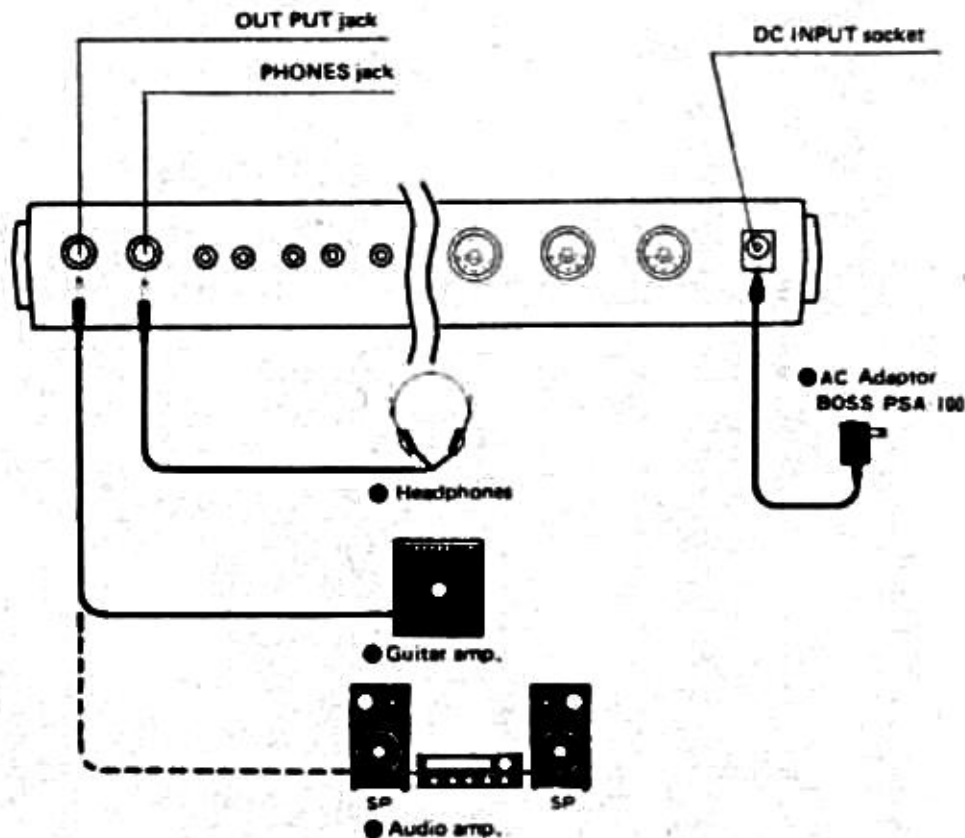

Headphones jack

Even if the headphones are being used, the signal is still sent from the OUTPUT. Also, please be sure to use stereo headphones (imp. $8\Omega \sim 30\Omega$). The beep that is heard during operation will not be output from this jack.

DC Input socket

If using the AC adaptor, plug it into this socket.

Use the BOSS PSA-120, 220 or 240 depending on the voltage system in your country. (Using any other adaptor may cause trouble.)

③ Entering(Basic)

A. Setting the synthesizer

If you enter each note listening to its sound from the synthesizer, it is easier to detect mistakes.

You can set the synthesizer to work as follows.

POWER

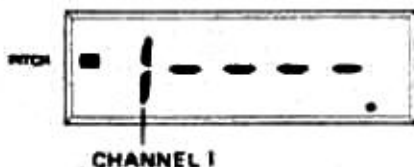

① You may enter Pitch data into the CH-1.

PLAY

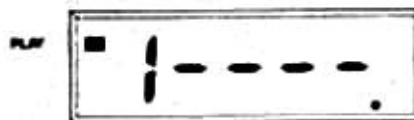

② The synthesizer may now be played.

You may change the setting to your taste.

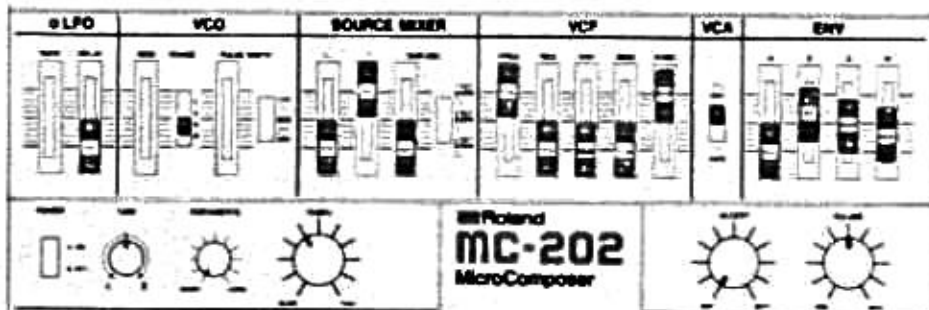

B. Entering the data with the STEP, GATE and NUMBER keys

First of all, enter the Pitch. If a rest comes up, enter the same pitch as the one just before.

1 Entering the Pitch

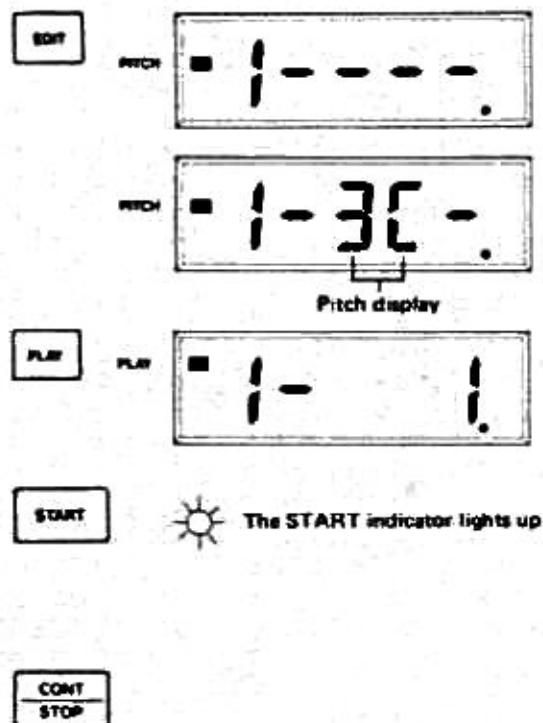

① You can enter the Pitch data.

- Play the keys according to the score.
- You will hear the same tone played on the keyboard, and the display window will also show it (e. g. Middle C:3C, g: upper right lights up).

② You can play the music data.

③ The music data will start playing.

- This data will automatically stop after played once. Also, the note instead of a rest is played.
- The tempo can be adjusted with the TEMPO knob.

④ You can stop playing in the middle, if you like.

After checking the pitch data is all correctly entered, edit the Step Time.

2 Editing the Step Time and the Gate Time

When the pitches are entered, all the notes will be automatically set to STEP TIME=24 (♩) and GATE TIME=12. Editing the Step Time and Gate Time will complete the data entry.

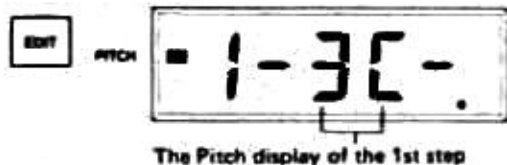

① You may edit the Pitch,



② You may edit the Step Time.

- The Step Time of the first step in the first measure will be indicated in the Display Window.

These are two ways of editing the Step Time and the Gate Time as shown below.

How to edit the Step Time and Gate Time

(Method ①)

With the GATE keys

(Method ②)

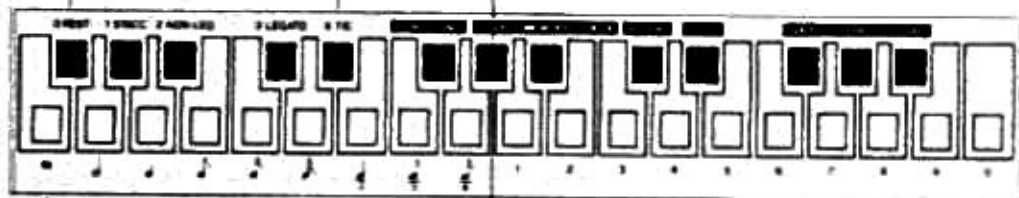

With the STEP keys

With the NUMBER keys

While editing the Step Time by using the STEP keys, you can also edit the Gate Time by using the GATE keys. If, however, using the NUMBER keys, you can

edit only the Step Time, so you need to edit the Gate Time later.

The functions of the STEP keys and the GATE keys are as shown below.

• Keys and Step Time

○ = 192	♩ = 6
♩ = 96	♩ = 32
♩ = 48	♩ = 16
♩ = 24	♩ = 8
♩ = 12	♩ = 4

• Gate Keys and Gate Time

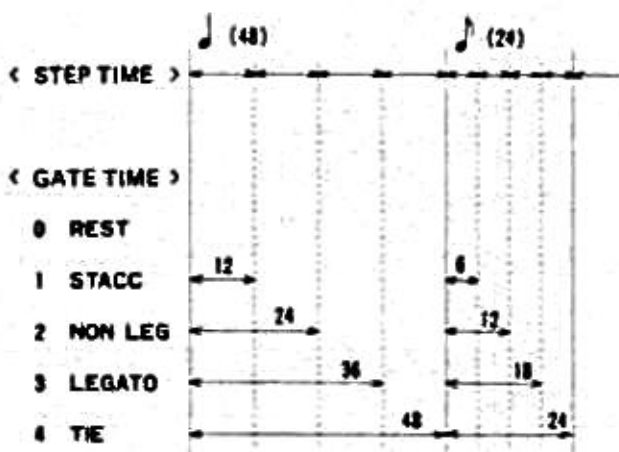

3 Editing with the STEP keys and GATE keys

Please edit from the first step in the first measure. You, however, do not need to change the ♩ notes, as ♩ = 24 is auto-

matically selected (default value) when the MC-202 is turned on.

If editing is necessary,

(STEP key)



(Display when STEP key ♩ is pressed)

① Set the Step Time

3 LEGATO



(GATE key)

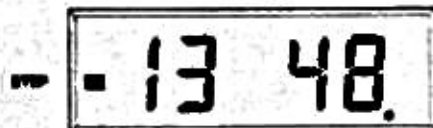

(Display when GATE key 3 LEGATO is pressed)

② Set the Gate Time

ENTER

STEP



Step Time of the 2nd note

- ③ Edit the Step Time and the Gate Time you have set.
The Display Window shows the Step Time of the next step.

Unless the ENTER key is pressed, the editing is not completed. Therefore, you may set any Step Time and Gate Time as many times as you like before pressing the ENTER key.

If the Gate Time of the notes are all different, you will need to set the Gate Time one by one, but if the note has the same Gate Time as the one before, you just need to press the ENTER key, so that the same Gate Time will be automatically selected.

Entering the dotted notes and dotted rests

To enter dotted notes and rests, press the BAR key instead of the ENTER key. e. g. press ♩ key, then the BAR key instead of the ENTER key for ♩., and the Step Time will be 36.

Entering the rest

In entering a rest, enter the note which has the same length as the rest, then press the 0 REST key.

Refer to the figure below.

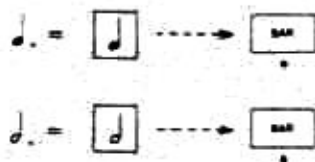

If editing is not necessary,

FWD

STEP

STEP



The Step Time of the next step.

- ④ Pressing the STEP FWD key will advance the step counter one step and the Display Window shows the Step Time of the next step.

If you have completed entering the Step Time and the Gate Time data, turn the MC-202 to the Play mode, then the data will be played.

OLDSCHOOL-SOUND
www.oldschool-sound.com

!!!!!! An exclusive free release !!!!!

SCAN by :: JC :: neko201@free.fr :: PRAJNA rocks !
Free manuals for Free Vintage addicts ! Creative use only

\$\$\$ Not For Resale \$\$\$

(Le bizness de ressources est un sport de ptizis :)

4 Playing

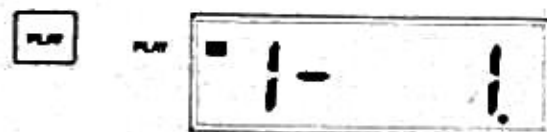

① The MC-202 is ready to play the data.



② The data will now be played.

If you wish to play the same data repeatedly, set the MC-202 to the Cycle mode. The SHIFT key is used to give two functions to one key, i. e. by pressing a key **while holding the SHIFT key down**, that key will have the function written above it.

How to repeat the data.

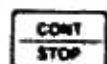

① Stop playing.

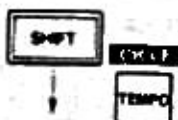

Cycle function ON

② Set to the Cycle mode.



③ If you start the MC-202 in this condition, the data will be played repeatedly until the STOP key is pressed. If you wish to leave the Cycle mode, press the STOP key, then press the CYCLE key while holding the SHIFT key down.

5 Editing the Step Time with the NUMBER keys

You can use the NUMBER keys instead of the STEP keys. For instance, if you wish to enter Step Time 48, first press 4, then 8. If you press a wrong key, press the 0 key three times, then again enter the correct number. Each time you press a NUMBER key, a beep will be heard. Again, unless you press the ENTER key, the Step Time is not edited. So make sure that the number displayed is correct, then press the ENTER key, and the next step is displayed ready to be edited. If editing

is not necessary, go ahead to the next step by pressing the STEP FWD key. When using the STEP keys, you will need to select the Gate Time as well. With the NUMBER keys. However, please just edit the Step Time one after another. After completing this procedure, go back to the first step in the first measure, then edit the Gate Time.

The following shows how to edit the Gate Time.

6 How to return to the first step in the first measure in the Edit mode

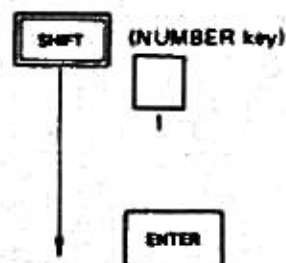

Release the ENTER key, then the SHIFT key. Be sure not to release the SHIFT key before releasing the ENTER key.

7 Editing the Gate Time with the NUMBER keys

Each time you press the EDIT key, the Edit mode changes as follows.

When the MC-202 is in the Gate Time editing mode, you may edit the Gate Time in the exactly same method as the Step Time editing.

Changing the Gate Time to zero will make a rest, and changing it into the same value as the Step Time will make a tie.

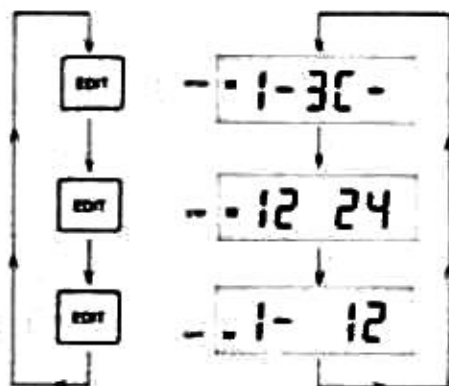

Example (1)

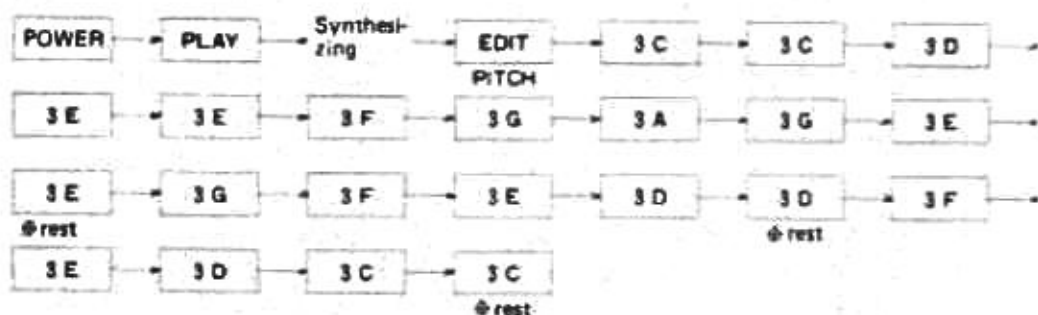

Now you have completed entering the Pitch data. Next, please check as follows.

PLAY → **START** All the notes are to be played in the same timing.

Edit the Step Time and the Gate Time.

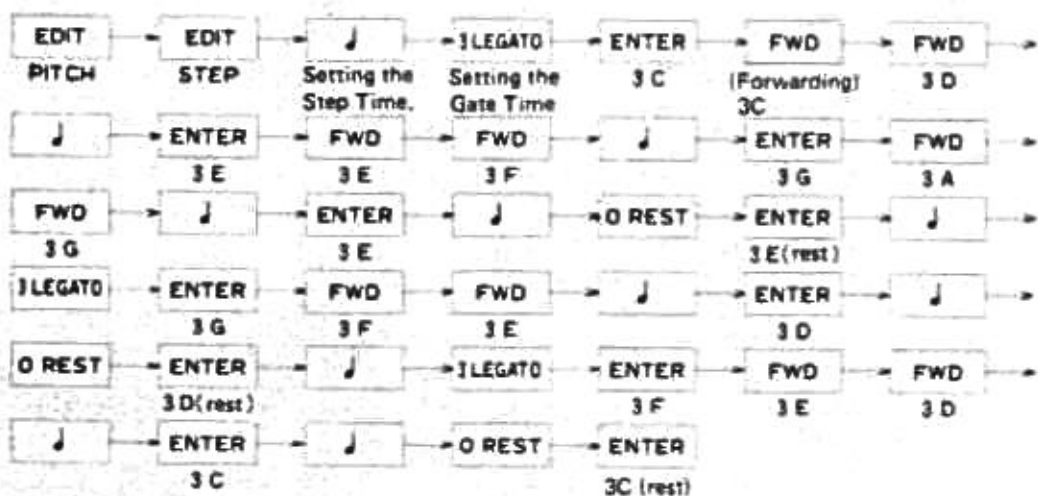

Note:

Now you have completed entering the Step Time and the Gate Time. Turn to the **PLAY** mode, then press the **START** key, and the music data you have just entered will be played.

C. Entering the data by playing the keyboard

There is another method of entering data, which is playing the keyboard to the metronome.

As the data is entered exactly as you are playing the keyboard, you will have to play accurately.

Also, using an external synthesizer (1V/

Oct) will make this job more comfortable. The metronome will sound as shown in the figure. The first two measures are just for getting used to the tempo, so start after you have heard two measures of the metronome.

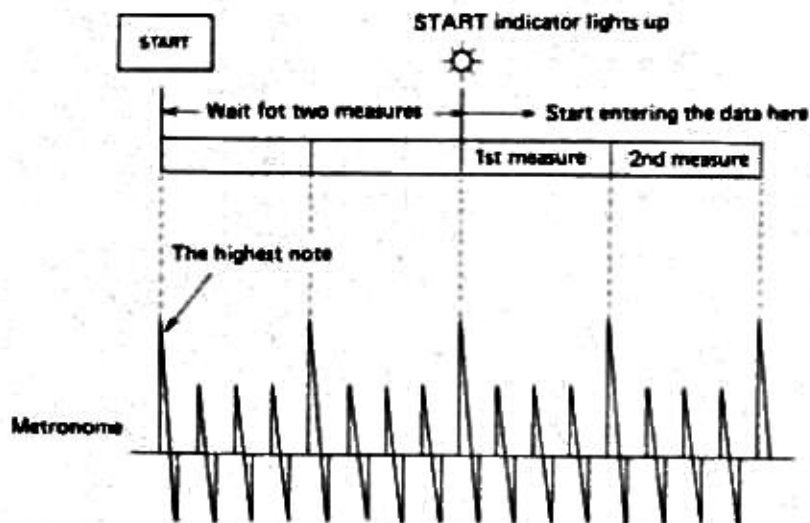

1 Connection

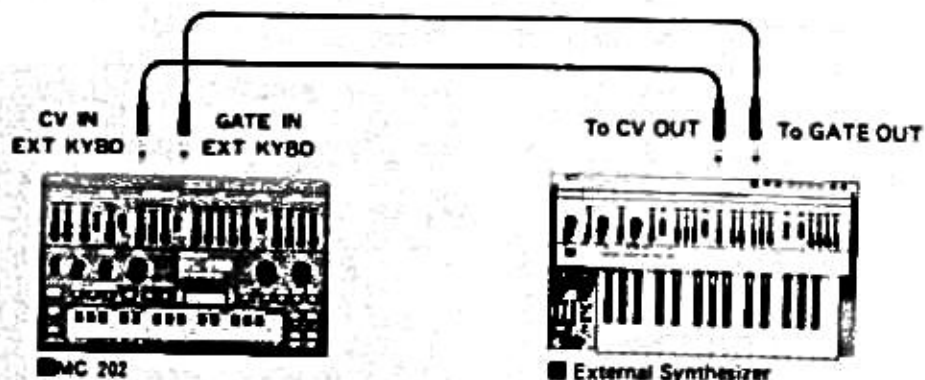

* Please use the Synthesizer (or Keyboard Controller) with 1V/Oct CV and Positive Gate Pulse (when on: +5 to 15V).

2 Operation

POWER



PLAY

EDIT (PITCH)

SHIFT

REAL TIME

NUMBER

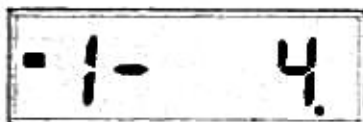

START

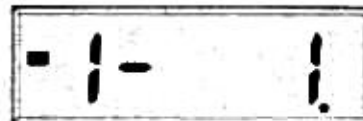

CONT
STOP

- ① You may enter the Pitch data.
- ② You may play the keyboard (you can synthesize the sound here).
- ③ You may enter the Pitch data.
- ④ You may enter the data by playing the keyboard.
You may enter the data in 4/4 time.
- ⑤ The metronome sound will be heard.
- ⑥ Wait until you hear two measures of the metronome sound, then start playing the keyboard.
- ⑦ Press the STOP key when you have played all the data.

If you wish to edit the music data you have entered, please start right from the beginning.

Entering music using other than 4/4 time
It is possible to change the time of the metronome, therefore, you may enter the music piece using triplet or irregular time. When you are in the procedure ④, set the time you like with the NUMBER keys. Then press the START key, and the metronome will sound in that set time.

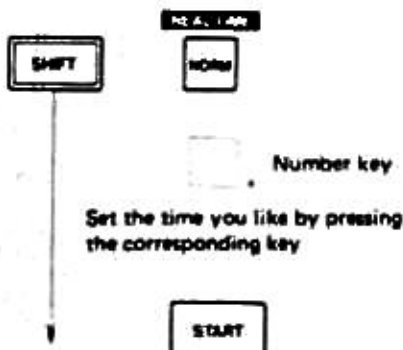

D. Entering the Pitch data by playing the keyboard and Rhythm data by tapping

After entering all the Pitch data by playing the keyboard, enter the Rhythm data (Step Time and Gate Time) by tapping the TAP key to the metronome. The metronome will sound as shown in the

figure. Please see when to tap the TAP key.

In entering the Rhythm data, again start after two measure of metronome sound.

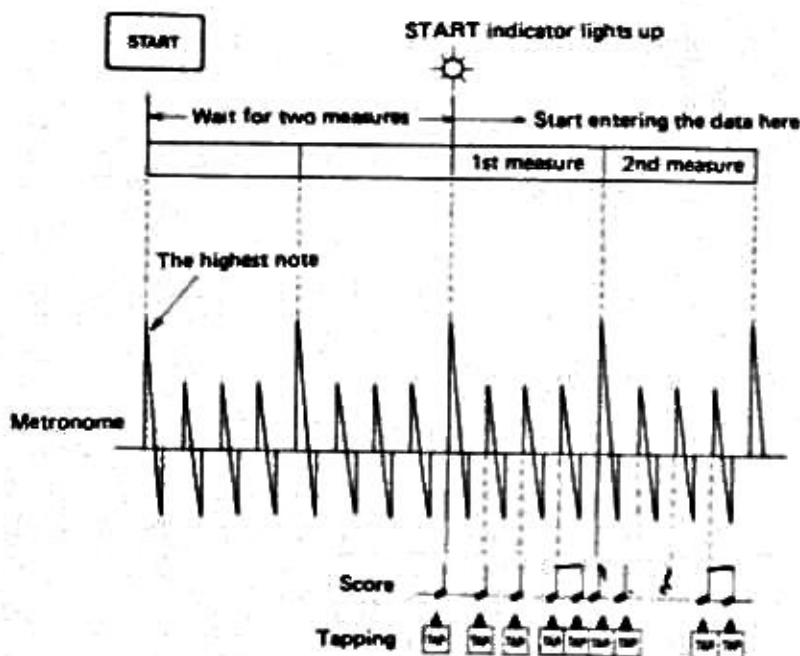

POWER



PLAY

EDIT (PITCH)

① You can enter the Pitch data.

② You can play the keyboard (you can also synthesize the sound).

③ You can enter the Pitch data.

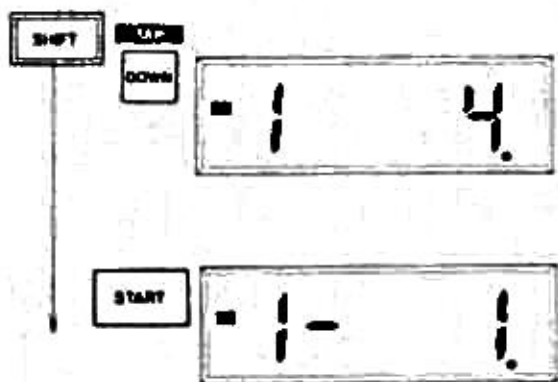

CONT
STOP

4. Enter all the Pitch data by playing the keyboard. (You do not have to enter a rest.)
5. You may enter the Rhythm by tapping the TAP key in 4/4 time.
6. You will hear the metronome sound.
7. Start tapping after two measures of the metronome. Please try to tap in the right rhythm.
8. Press the STOP key after the last note is tapped.

You may adjust the tempo by rotating the TEMPO knob.

Each time you press the TAP key, you will hear the sound (the Pitch entered), and the Step Time and Gate Time will be entered in the same rhythm as you tap. If you wish to edit the data, do it right from the beginning.

Entering the Music Data using other than 4/4 time

Just like "C. Entering the data by playing the keyboard P. 20", you can change the time of the metronome.

In the procedure (5), set the time you like with the NUMBER keys as shown below. Then press the START key, and the metronome will sound in the set time.

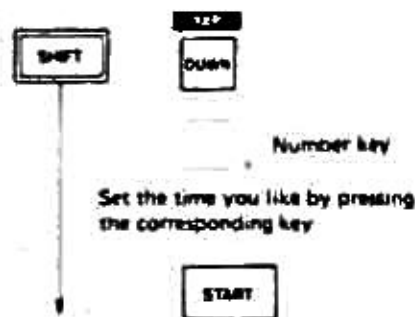

Set the time you like by pressing the corresponding key

4 Entering data(Advance)

A. Entering data into the CH-2 and playing it

"Entering data (Basic)" only refers to entering data into the CH-1. If, however, you use both CH-1 and CH-2, a synthesizer duo is easily available. In this case, an external synthesizer (1V/Oct) will be required. On connecting it to the MC-202, please tune it

with the MC-202's synthesizer. Also, if entering a different music data into the CH-2, you can alternately play the two different music data. In this case, the external synthesizer is not necessary.

1 Connections

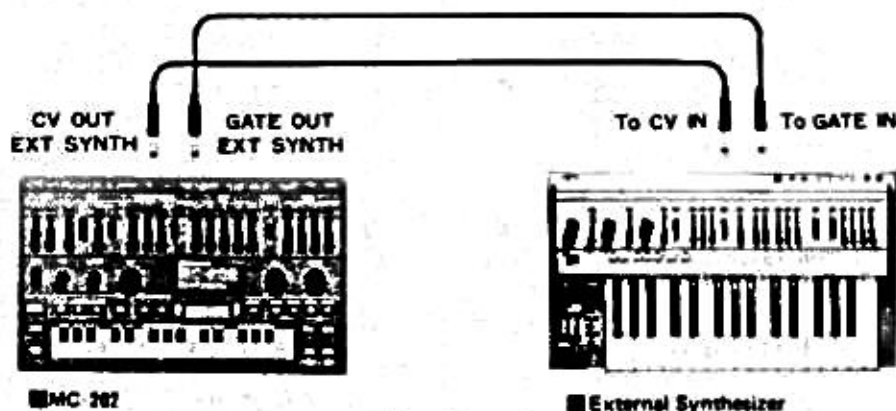

* Please use the synthesizer with 1V/Oct CV and Positive Gate Pulse.

2 Tuning

- ① Check if all the connections have been correctly made.

Enter the data for tuning into the MC-202.

- ② You can edit the CH-1 (i.e. you can enter the Pitch data).

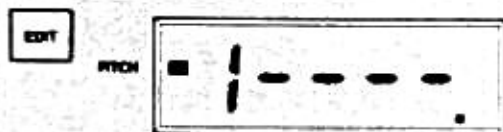

③ Enter the data as follows.

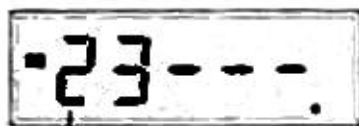

Displaying the CH-2.



④ You can edit the CH-2.

⑤ Enter the same data as you entered in the procedure ③.

⑥ To produce long tone, set the synthesizer's controls as shown in the figure below.

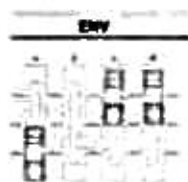

⑦ Turn the Cycle function on.

⑧ Start playing
The music data (2 CH's) for tuning will be played.

⑨ Tune their pitches by using the Tuning knob of the MC-202 and the external synthesizer.



Now you have completed tuning

The music data for tuning is here set to 3A (440 Hz), but any other note will do. Also if tuning by using a tuning fork or a tuner, tune each synthesizer separately.

OLDSCHOOL-SOUND
www.oldschool-sound.com
!!!!!! An exclusive free release !!!!!!

SCAN by :: JC :: neko201@free.fr :: PRAJNA rocks !
Free manuals for Free Vintage addicts ! Creative use only
\$\$\$ Not For Resale \$\$\$
(: Le bizness de ressources est un sport de ptizis :)

3. Checking the Channel, Entering data and Playing

The Display Window will change as shown in the figure as you select the channel for entering.

You can change the channel at any time except when the MC-202 is playing the data.

If entering the data by playing the keyboard (P. 20) or tapping the TAP key (P. 22), it is possible to listen to the music data entered in the other channel simultaneously.

aneously

You do not need to select the channel for playing, but you can select the synthesizer (the UC-202's or external synth) to play each data by changing the channel.

*If the bars of the CH-1 or CH-2 are not correctly entered, the Display Window will fail to show the correct measure number.

How to channel is changing

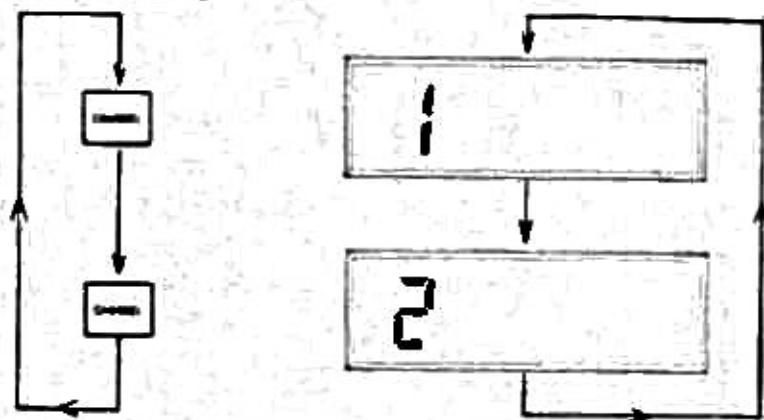

How the synthesizer to play each data changes.

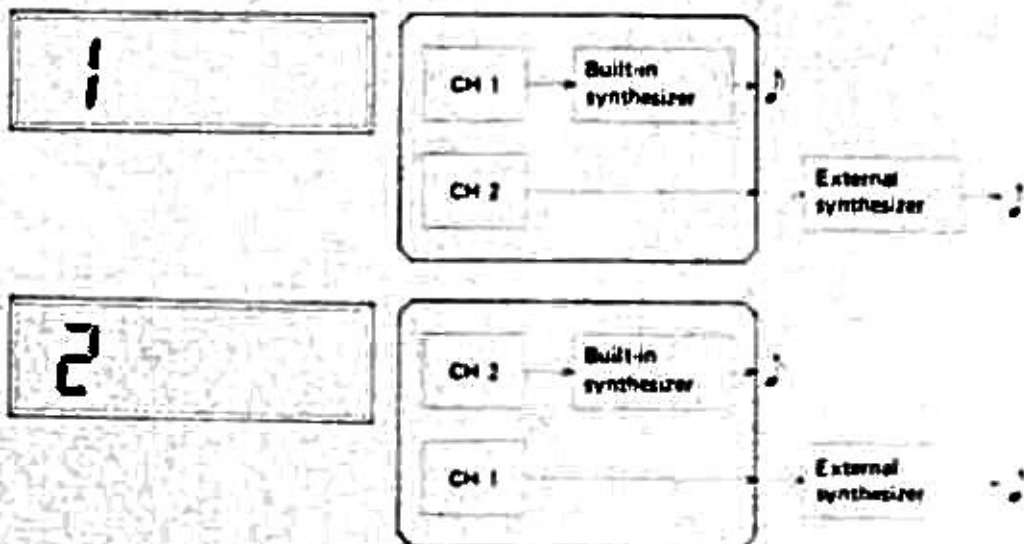

B. Entering Accent and Portamento

It is also possible to enter Accent and Portamento etc.

1 Entering Accent and Portamento

Accent (ACC)

As shown in the figure, you may give an Accent to any note you like.

Portamento (PORTA)

As shown in the figure, enter the Portamento to the last note of the two notes to which you wish to give a Portamento effect. The Portamento will also effect the external synthesizer, but the Accent is available only on the built-in synthesizer.



2 How to enter Accent and Portamento

There are two main methods of entering Accent and Portamento.

- ① Entering while you are editing the Step Time.
- ② Entering after you have finished all of the entering procedure.

Method ①

Set the Step Time, then press the Accent (or Portamento key) before pressing the ENTER key.

Method ②

After you have completed all the entering procedure, do as follows.

EDIT (STEP)

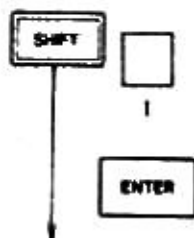

① Set the MC-202 so that you can enter the Accent and Portamento (*Step Time editing mode).

② Go back to the first step in the first measure.

FWD
STEP

TAP
ACC

STEP

- 12 24 -

ACC

③ By pressing the STEP FWD key, get to the step to which you wish to give the Accent or Portamento effect.

④ Enter the Accent (or Portamento) by pressing the Accent key (or Portamento key).

TAP
PORTA

STEP

- 12 24 -

PORTA

⑤ Repeat ③ and ④ procedures.

When you have completed the music entry, turn the MC-202 to the Play mode. Then see how each effect works by rotating its knob.

*If you have entered the Portamento effect to the both channels, you cannot set different Portamento times. When you make a mistake, press the Accent key (or Portamento key) and the bad data will be cleared.

OLDSCHOOL-SOUND
www.oldschool-sound.com
!!!!!! An exclusive free release !!!!!!

SCAN by :: JC :: neko201@free.fr :: PRAJNA rocks !
Free manuals for Free Vintage addicts ! Creative use only

\$\$\$ Not For Resale \$\$\$
(Le bizness de ressources est un sport de ptizis :)

3 Assigning the Accent effect

The notes with Accent usually control the VCA, but it is possible to control both the VCF and VCA.

*Refer to the separate volume "MC-202's Synthesizer".

PLAY

① The MC-202 is in the Play mode.

SHIFT

NOTE

1- FA

Displaying "VCF"
Displaying "VCA"

(The Accent works on both the VCF and VCA.)

② The Display Window displays that the Accent works on both the VCF and VCA.

NOTE

1- A

(The accent works only on the VCA).

③ Now the Accent works only on the VCA.

C. Useful Functions(in Entering)

1 Moving the data onward and backward.

In the edit mode, each time you press the STEP FWD key, the data will move one step forward, and by pressing the STEP BACK key, the data will move one step backward.

In the edit mode, if pressing the STEP BACK key while holding the STEP FWD key while holding the STEP BACK key, you can quickly move the data backward.

During moving back the data, two beep sounds will be heard where a bar is entered. (This function is useful to know the positions of the bars.)

2 Transpose function

You can transpose the entire keyboard one octave up or down. If using this Transpose function while entering the Pitch data, you can move the music data up to 4 octave and half. (refer to P. 59)

While entering the Pitch data by playing the keyboard, if your pitch data exceeds the sound range of the MC-202 keyboard, press the UP key and if it does not reach the range, press the DOWN key. The note one octave higher or lower will sound and be entered.

Pressing the NORM key will return the keyboard to the normal condition. This function is available even in the Play mode (except when the data is being played).

D. How to correct the data you have entered

If the pitch is wrong



Correcting the Pitch data (P. 31)

If the timing value is wrong



Correcting the Step Time and Gate Time (P. 31)

If there are too many (or too less) notes entered



Deleting and inserting notes (P. 33)

1 Correcting the Pitch



(PITCH)

① You may correct (change) the pitch data.

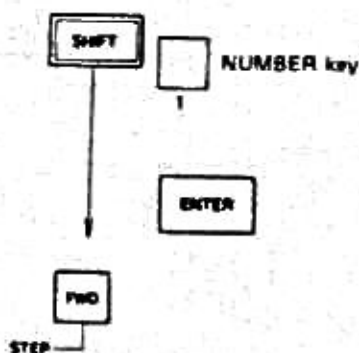

② Go back to the first step in the first measure

③ By pressing the STEP FWD key, get to the step just before the one you wish to correct.

④ By playing the keyboard, enter the correct pitch
The played note will sound and be replaced with the wrong (old) one.

While forwarding the data by pressing the STEP FWD key, a rest will not sound. Also, a tie will sound as one note.

2 Correcting the Step Time and the Gate Time

There are two ways of correcting the Step Time and the Gate Time (P. 13). Basically the procedure is exactly the same as that of P. 14.

Using the STEP keys and the GATE keys

EDIT (STEP)

① You may change the Step Time data.

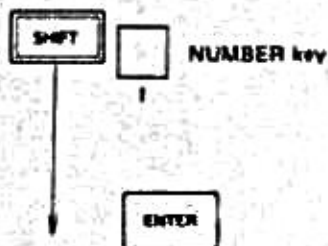

② Return to the first step in the first measure.

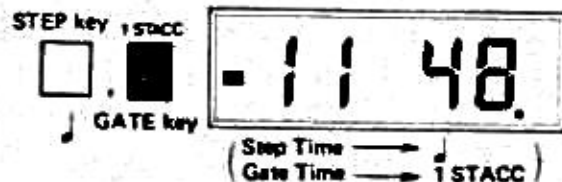
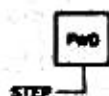

- ③ By pressing the STEP FWD key, get to the Step Time just before the one you wish to change.
- ④ Set a new Step Time and Gate Time. Even if you wish to edit only the Step Time (or Gate Time), you have to set both data.
- ⑤ Now new Step Time and Gate Time are entered.

Editing with the NUMBER keys

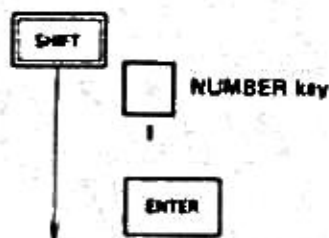

- ① If you wish to edit the Step Time, select the Step Time Edit mode, and if the gate Time, The Gate Time Edit mode.
- ② Go back to the first step in the first measure.

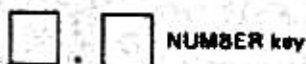

- ③ By pressing the STEP FWD key, forward the Step Time (or Gate Time) to just before the one you wish to correct.
- ④ Set a new Step Time (or Gate Time) with the NUMBER keys.
- ⑤ Now the new Step Time (or Gate Time) is entered.

3 Deleting and Inserting notes

It is possible to delete or insert notes.

How to delete the notes

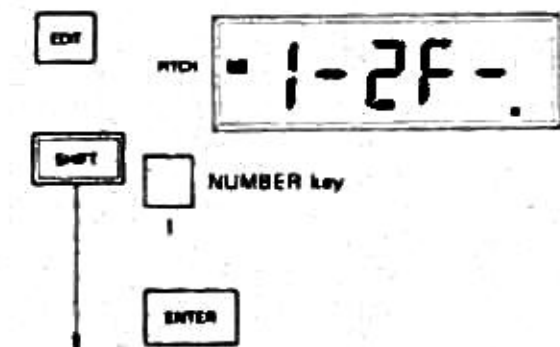

① Set to the Pitch Edit mode.

② Return to the first step in the first measure.



③ By pressing the STEP FWD key, get to the note just before the one you wish to delete.

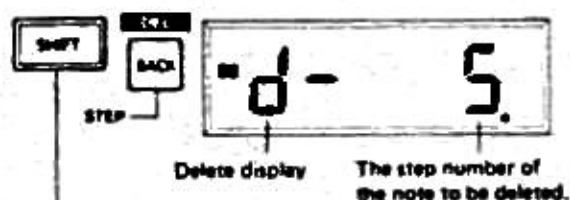

④ You may delete the note.

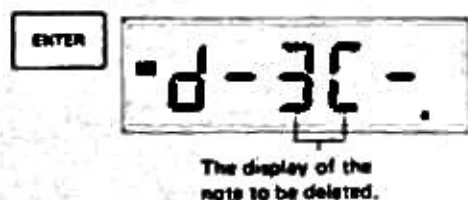

⑤ The note to be deleted will sound and be deleted.

By repeating the procedure 5, you can delete as many notes. If the bars are entered, deleting the last note of the measure will delete the bar at the same time.

OLDSCHOOL-SOUND
www.oldschool-sound.com

!!!!!! An exclusive free release !!!!!!

SCAN by :: JC :: neko201@free.fr :: PRAJNA rocks !
Free manuals for Free Vintage addicts ! Creative use only

\$\$\$ Not For Resale \$\$\$

(Le bizness de ressources est un sport de ptizis :)

How to insert notes

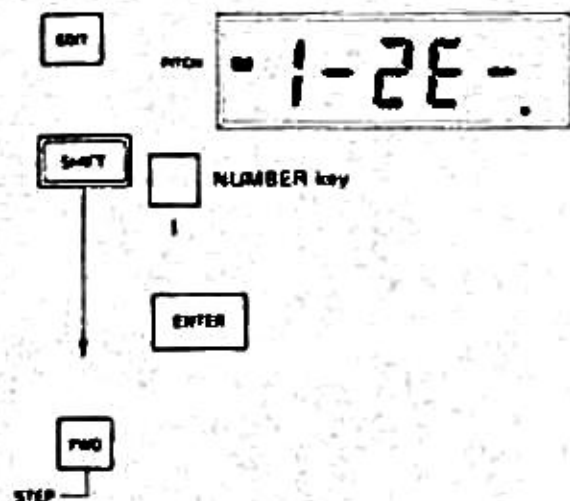

- 1 Set to the Pitch Edit mode.
- 2 Return to the first step in the first measure.
- 3 By pressing the STEP FWD key, get to the note that is to be followed by the inserted note.
If you wish to insert a note between the second step and third step, get to the second note.

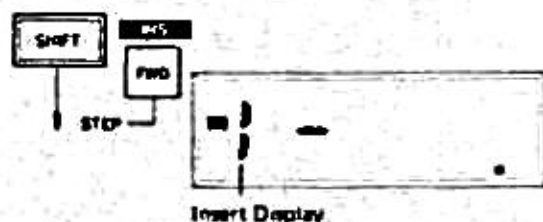

- 4 You can insert a note.
- 5 Enter a note to be inserted by playing the keyboard.
- 6 The note played on the keyboard will be entered.



At this stage, you can enter as many notes as you like, and also the bars. Be sure to press the ENTER key in the very end. The Step Time=24 and Gate Time=12 are automatically selected (Default) when the Pitch data is entered.

It is not possible to insert a note between the last note of the measure and the bar.

5 Useful functions by bars

- Playing or editing from the measure you select
 - Forwarding or backing the whole measure
 - Copying the data
 - Deleting the whole measure
 - Others
- * Refer to P. 19 for entering the bars.

A. How to set the bars, etc.

1 Measure number display

Pressing the SHIFT key will display which measure you are entering. (Except for the data playing mode).

In the Play mode

While the data is being played, the current measure will be displayed. Even when stopped, the measure number will be displayed.

2 How to forward or back the whole measure

Pressing the MEAS FWD key will forward one measure and MEAS BACK key will back up one measure. While the MEAS FWD key or BACK key is being pressed, the display window shows the measure number.

On releasing the key, the Display Window shows the first step in that measure.

3 How to recall a measure

You can recall any measure by doing as follows.

B. Playing and Editing from the measure you select

1 Playing from the measure you select

Select a measure in the Play mode, then press the **CONT STOP** key, and the data will be played from that measure.

In the Edit mode

If entering the data by playing the keyboard or tapping the TAP key, you will see the Display Window change with the beep. If you enter the data with the keys, the measure number is not displayed at all.

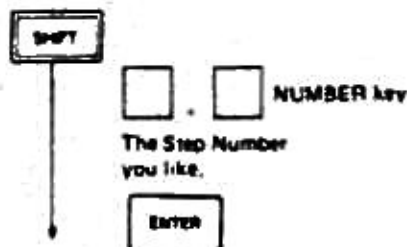

2 Editing from the measure you select

Editing with the STEP keys and GATE keys

If you select a measure in the Edit mode, you can edit the data from the first step in that measure. (The Display Window shows the first step in that measure.)

Editing by playing the keyboard or tapping

*With the STEP keys and GATE keys, you can edit even only one note, but by playing the keyboard or tapping, you are required to edit the whole data (from the selected measure to the very end).

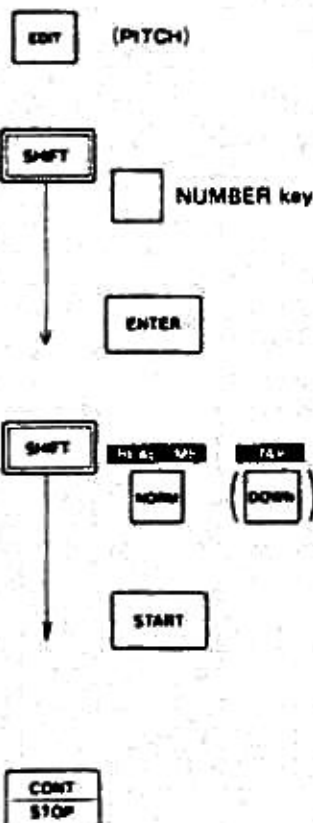

① Set to the Pitch Edit mode.

② Select the measure.

③ You can change the data by playing the keyboard or tapping the TAP key.

④ Start editing the data.

⑤ Stop editing.

The measure number shown in the Display is counted from the selected measure.

If you are editing by playing the keyboard, all the data from the selected measure to the very end will be erased (i.e. you are to enter new data of that amount later).

3 How to delete the whole measure

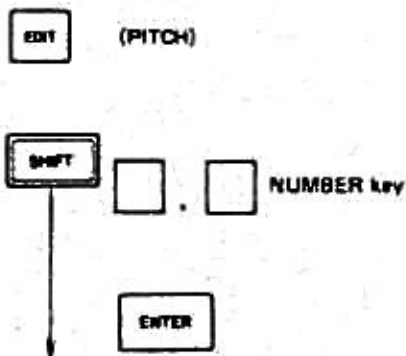

① Set to the Pitch Edit mode.

② Recall the measure to be deleted by using the NUMBER keys or the FWD key.

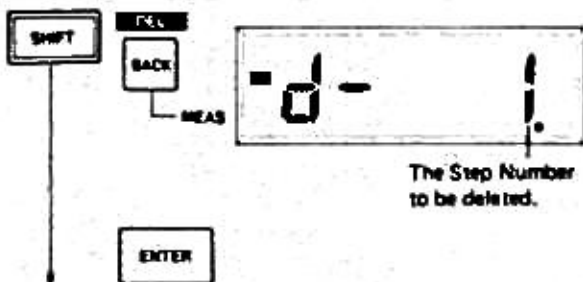

③ Delete that measure.

④ The measure you selected in the procedure ② will be deleted.

By repeating the Procedure ④, you can delete as many measures as you like.

4 Editing the bars

If you wish to add, delete or move the bars, do as follows.

Adding bars

Referring to "How to enter the Bars P.19", you can enter additional bars.

OLDSCHOOL-SOUND
www.oldschool-sound.com

!!!!!! An exclusive free release !!!!!

SCAN by :: JC :: neko201@free.fr :: PRAJNA rocks !
Free manuals for Free Vintage addicts ! Creative use only

\$\$\$ Not For Resale \$\$\$

(Le bizness de ressources est un sport de ptizis :)

Deleting bars

EDIT (PITCH)

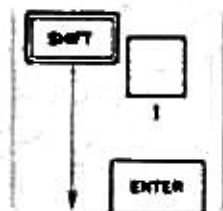

① Set to the Pitch Edit mode.

② Return to the beginning of the first measure, if necessary.

STEP
FWD



The note just before the bar.

③ By pressing the MEAS FWD key, get to the note second last from the bar to be deleted.

The Display Window shows the note just before the bar.

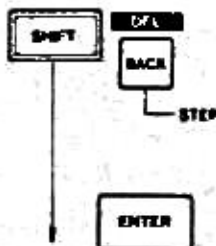

④ Now you can delete.

⑤ The bar and the note just before it will be deleted.

Please note that the note before the bar is deleted, so that you need to enter a note for replacement referring to "How to insert notes P. 34".

Moving the bar

By adding and deleting a bar, you can easily move the bar position.

C. How to copy the data

You can save quite a lot of work by copying the measures already entered. For instance, if you recall the third measure, it will be copied to just after the fourth, (i.e. it will be the fifth measure.) Please refer to the figure.

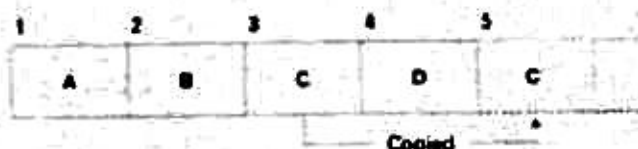

EDIT (PITCH)

① Set to the Pitch Edit mode.

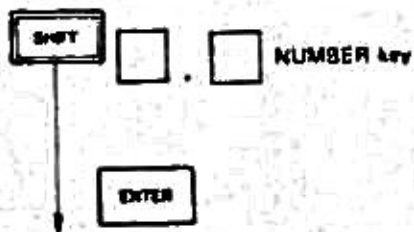

② Referring to "Recalling the measure P. 35", select the measure to be copied.

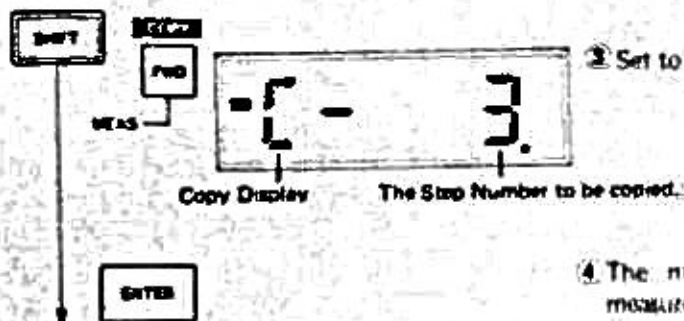

③ Set to the Copy mode.

④ The measure you have selected (the measure shown in the Display Window) will be copied after the last measure entered.

By repeating the procedure ④, you can copy as many measures as you like. (Refer to the figure.) This Copy function includes copying the Pitch, Step Time and Gate Time.

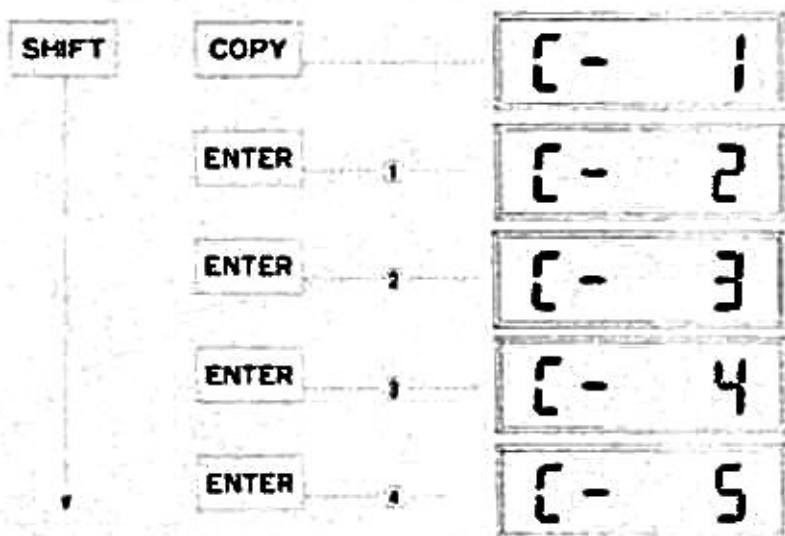
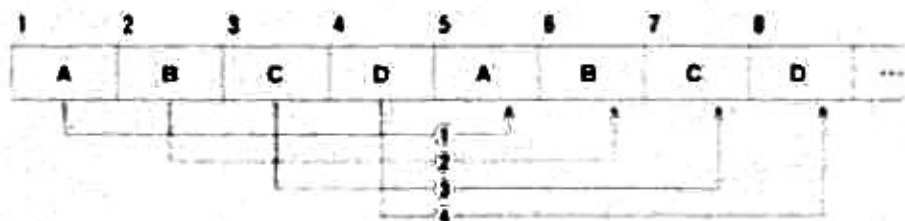

6 Other useful functions

The MC-202 offers some more useful functions.

A. Tempo display

Pressing the TEMPO key will display the current Tempo.

*It needs a few seconds before you get an accurate tempo display.

The following procedures should be all done while the MC-202 is stopped in the Play mode.



B. Memory Capacity Check

You can easily see how many more notes can be entered into the MC-202. Do as shown in the figure, and the Display Window will show it with figures.

How to read the Display Window

Usually it will show the four figure number. A blank, however, is to be regarded as zero.

Memory Capacity

The maximum memory capacity of the MC-202 altogether (CH-1, CH-2) is approx. 2600 steps. This means approx. 160 measures of 8th notes in each measure can be entered. A bar costs 1/3 step.

If all the memory capacity is used up, entering is no longer possible.

(If you still press a key, a beep will continuously sound.)

If, however, you are entering the data by playing the keyboard, there is no warning signal and entering more data will break the whole existing data, so please be sure to stop entering within 2600 steps.

Also, the action of the MC-202 may become more and more sluggish as the data is being entered. If so, please make sure that the mode or channel is changed, before going to the next procedure.



Example	Measure Number	Display
	2103	2 103
	2084	2 84
	1008	1 8
	0334	0334
	0024	0 24
	0006	0 6

C. Step Number Check

You can see the Total Step Time (Step number) in a measure. If music in 4/4 time is entered, the total step times in one measure is bound to be 192 as \downarrow is step time 48.

By checking this Total Step Time, you can avoid entering too many or too few steps.

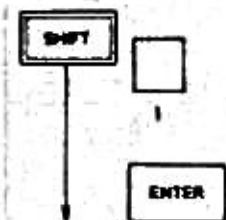

- ① If you wish to check from the first measure, return to the beginning of the data.

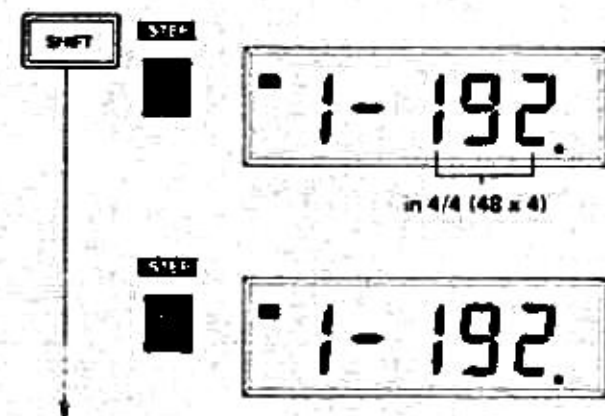

- ② The Total Step Time of the first measure will be displayed.



- ③ The Total Step Time of the second measure will be displayed.

By repeating the same procedure, you can check as many measures. (Pressing the STEP CHECK key will forward one measure.)

If the Total Step Time is not correct

If you find a mistake while checking, do as follows.

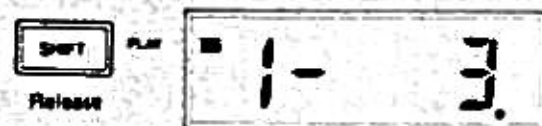

- ④ Release the SHIFT key.

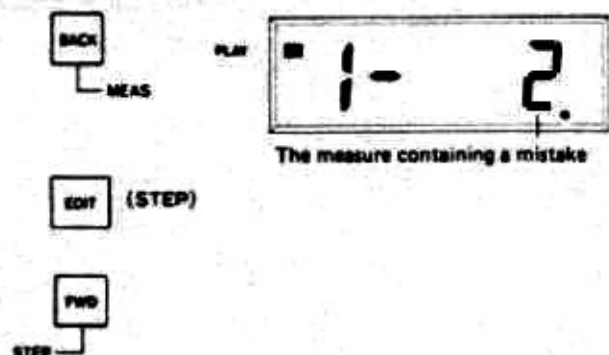

② Back one measure by pressing the BACK key.

There is a mistake in the measure displayed.

③ Set to the Step Time Edit mode and get to the relevant step by pressing the STEP FWD key.

④ Referring to "Editing the Step Time P. 14", delete or insert necessary notes.

D. # and b display

Pressing the black key on the keyboard will automatically display # in the Display Window, but you may change it to b.

Then later you can easily check if the score has been correctly entered. Do as shown in the figure, then press the black key, and now the Display Window will show "b" indicator.

Repeat the same procedure shown in the figure, and the # display will return.

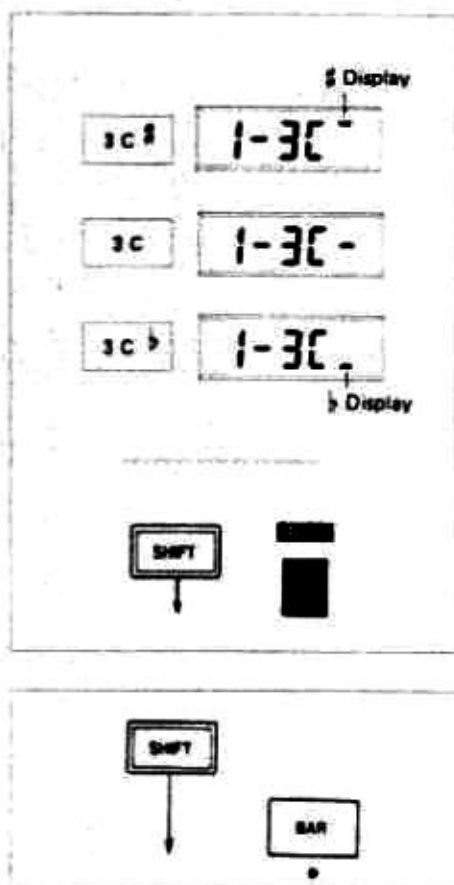

E. Beep sound ON/OFF

If you do not need the beep during operation, you can mute it as shown in the figure. To retrieve it, repeat the same procedure.

7 Saving the Music Data

A. Save, Verify, Load

You can save the music data you have entered on a normal tape. Please make it a rule to save the data before turning the MC-202 off.

B. Setting up

Set up a tape recorder with the MC-202 as shown below.

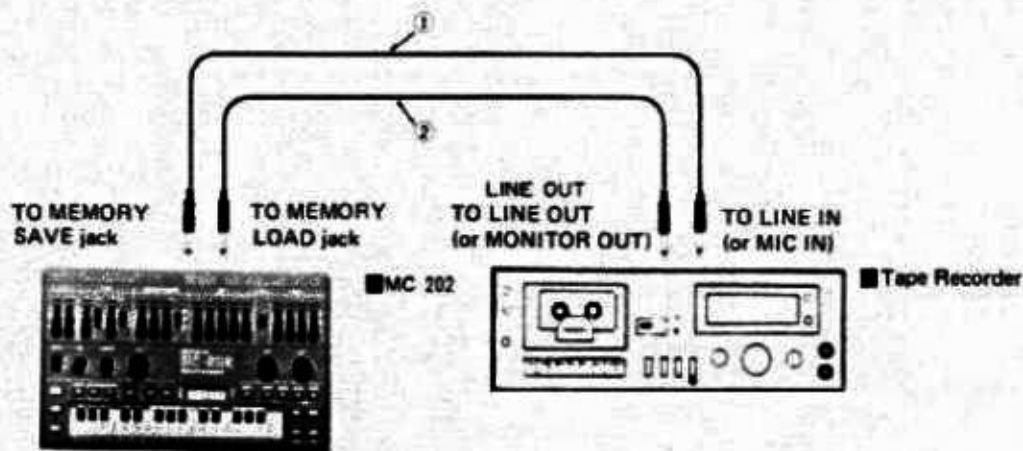

✦ If you only want to save, connection 22 is not necessary.

✦ If you only to load (or verify), connection 11 is not necessary.

C. Operation

All the procedures should be done when MC-202 is stopped in the Play mode.



www.oldschool-sound.com

!!!!!! An exclusive free release !!!!!!

SCAN by :: JC :: neko201@free.fr :: PRAJNA rocks !
Free manuals for Free Vintage addicts ! Creative use only

\$\$\$ Not For Resale \$\$\$

(Le bizness de ressources est un sport de ptizis :)

1 Save

If you put a File Number to each song when in saving, later on, song recalling will be much easier.

0 to 999 are available for the File Numbers

and can be set by pressing the appropriate NUMBER keys.

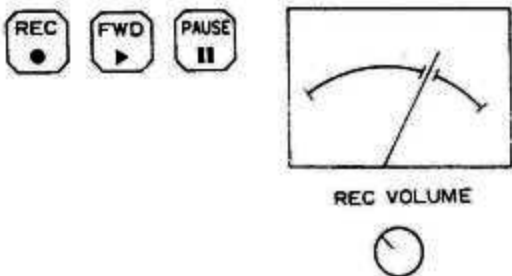

- ① Set the tape recorder to the Recording mode and press its PAUSE button.

If your tape recorder features recording level control, set the volume so that the Pilot tone from the MC-202 will read OVU or so.

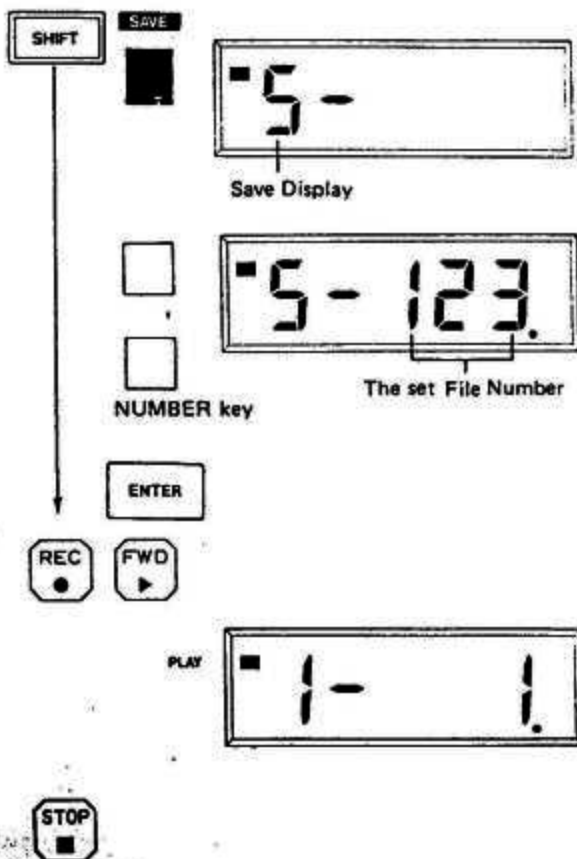

- ② Now saving is possible.

- ③ Set a File Number.

- ④ Press the ENTER key then turn the tape recorder to the Recording mode. By pressing the ENTER key, the Pilot tone will become higher, then in about 7 seconds, the saving into the tape starts (Modulated tone will be heard). When the saving is completed, you will hear a beep, then again the Pilot tone.

- ⑤ Stop the tape recorder.

2 Verify

Be sure to verify the data after each saving.



- ① Adjust the output level of the tape recorder, then set it to the Playing back mode.

Be sure to start the tape from the very beginning where you can hear the Pilot tone.

Complete the following two procedures while you hear the Pilot tone.

- ② Now you can verify the data.

- ③ Verifying starts and the Display Window shows the File Number. If verifying is completed, a beep will be heard.

- ④ Stop the tape recorder.

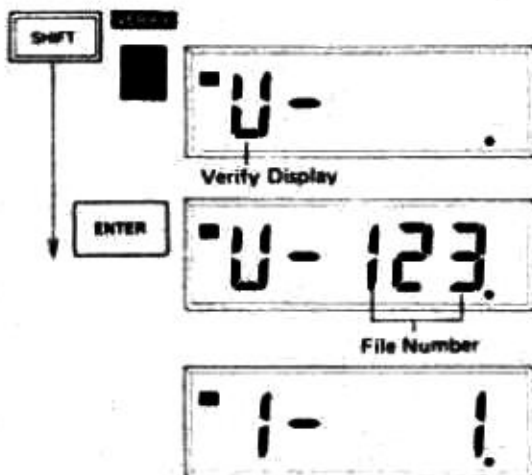

Be sure to complete the procedures while still hearing the Pilot tone. If you are too early or too late, a continuous beep will be heard indicating an error. Also, if the playback level is too low, the beep may be heard. If so, try again with a higher level. If

an error is heard, even though you have correctly done the verify procedure, please repeat the save procedure.

If the error is still indicated, refer to "D. The appropriate tape to be used for saving on P. 48".

3 Load



- 1 Adjust the output level of the tape recorder then set it to the Play mode. Be sure to start loading from the very beginning of the tape where you hear the Pilot tone.

While you still hear the Pilot tone, complete the following two procedures.

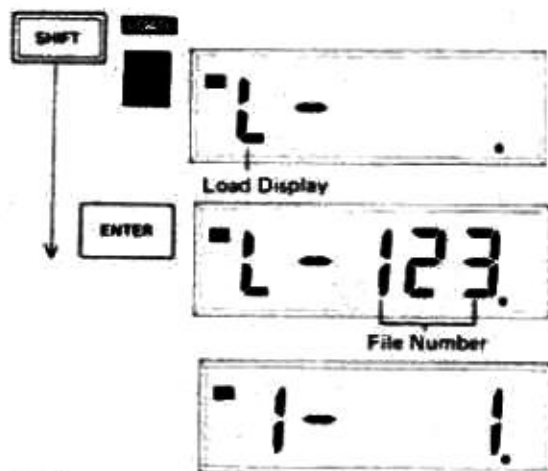

- 2 Loading is now possible.
- 3 Loading starts and the Display Window will show the File Number. When loading is completed, a beep will be heard.

- 4 Stop the tape recorder.

Be sure to complete the above procedures while still hearing the Pilot tone. If you are too early or too late, a continuous beep will be heard indicating "error".

Also, if the playing back level is too low, error may be heard. If so, try again with a higher level.

Also, if the Pilot tone recorded when saving is low, wait until it becomes higher, and start the above procedures. If not, an error will be heard (Refer to the figure).

If an error is indicated, even if you have correctly done all of the loading procedures, refer to "D. The appropriate tape to be used for saving on P. 48".

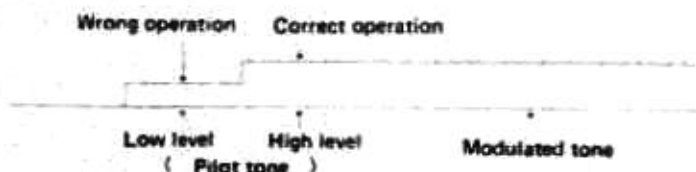

When the File Number is displayed in procedure ⑤, check if it is the correct one. If it is not what you want, stop the tape (loading mode is cancelled) and repeat the load procedure.

D. The appropriate tape for saving

The saving error is often caused by the tape you use. Please make sure that the tape has no dropout, and moreover, clean the head of the tape recorder.

Preserving the data tape, etc.

Please rewind the tape and avoid keeping it in excessive humidity and where it may be affected by a strong magnetic unit (such as speaker, amplifier etc.). If the data is an important one, save it on two tape so that you can avoid an accidental erasure of the entire data. Please do not copy from one tape to another, but load the data back to the MC-202 then save it to another tape.

E. Power Save Function

The MC-202 features the Power save function which can be effectively used to avoid unnecessary battery consumption. Turn this Power save function on as shown in the figure, and the MC-202 does no longer functions but only retains the entered data.

Repeat the same procedure to turn this function off.

*Even if the Power save function is ON, turning the POWER switch off will erase the data, so please be sure to keep the Power on.

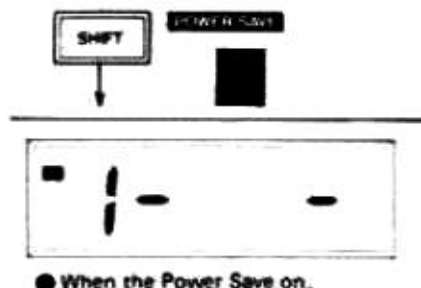

8 Applications

A. Integrating the set up of the MC-202

The function jacks on the MC-202 can be used for more integrate set up, and following is made possible.

Controlling the MC-202 by the external keyboard
2 Channel playing
Synchronizing the MC-202 with the se-

quencer and Rhythm machine
Synchronizing of more than two MC-202's
Multi-recording using the Tape Sync function
Others

The figure shows the example connections.

● SYSTEM SETTING UP

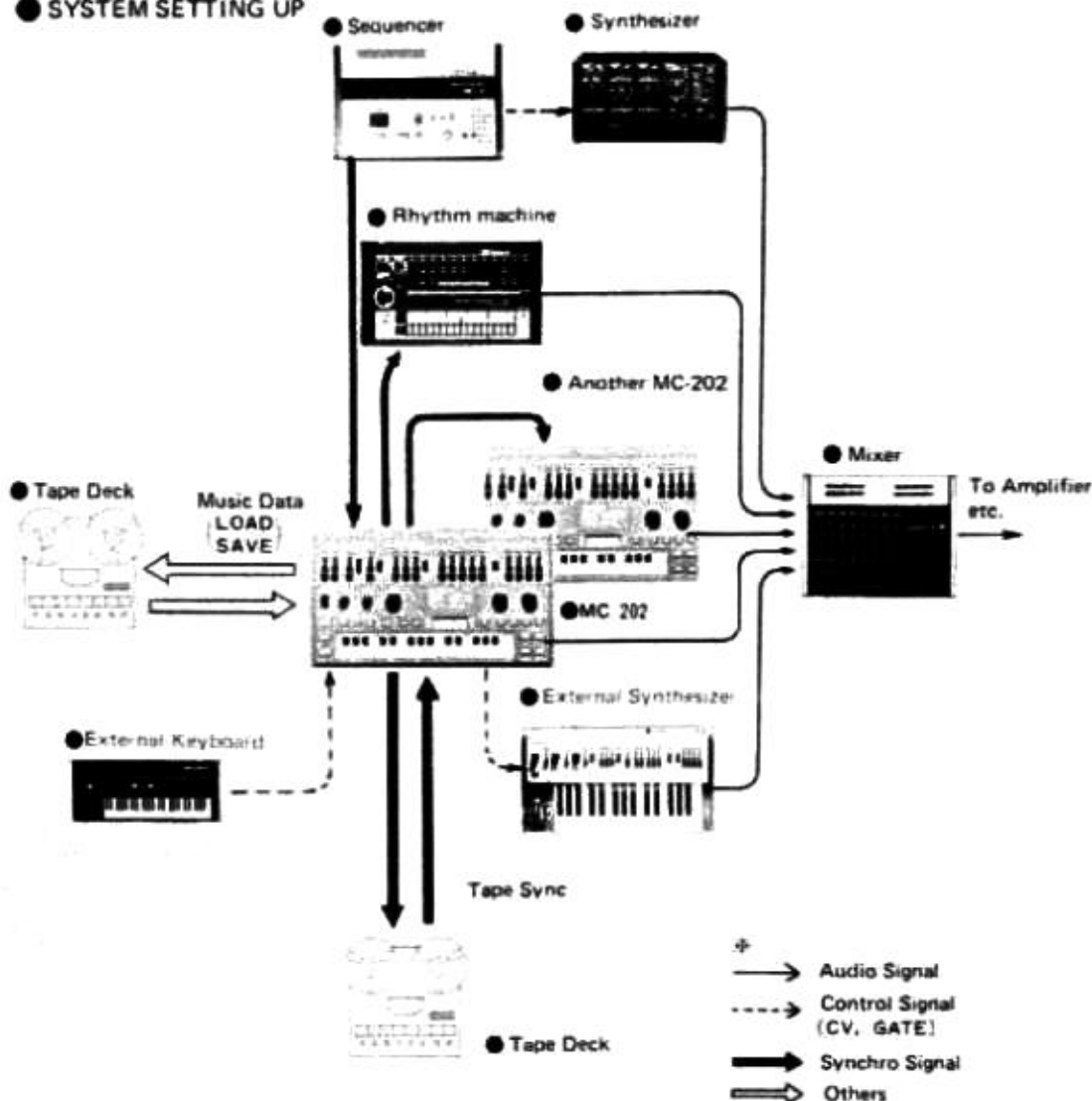

B. Rear Panel

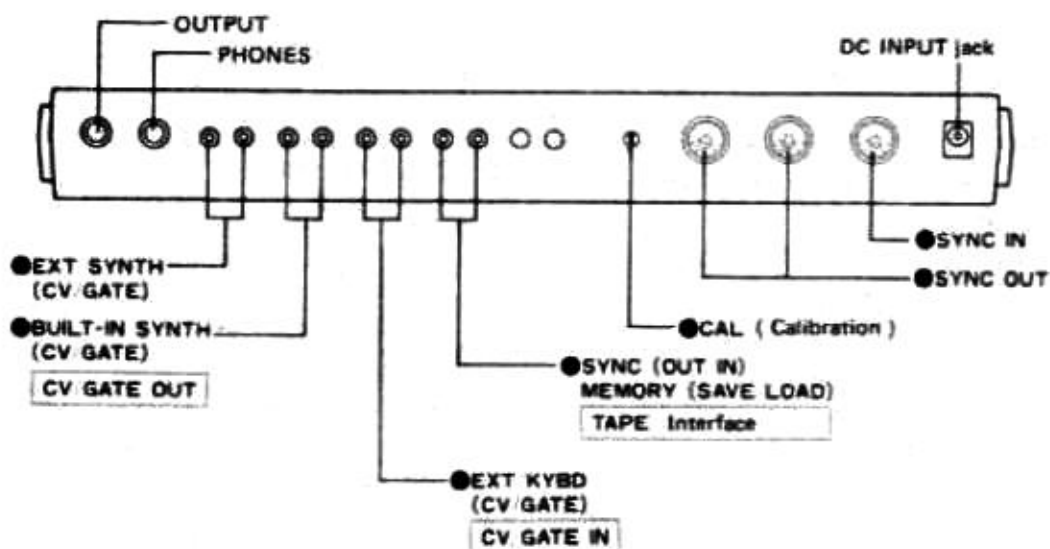

C. Connecting to a synthesizer

Controlling the MC-202 by the external keyboard

You can enter and play the music data with the keyboard of the external synthesizer.

The available keyboard is the one featuring 1V/Oct CV and positive gate pulse (+5 to 15V) such as the SH-101, SYSTEM 100M (D-set, M-184), etc.

Even if the external keyboard is set up, you can use the MC-202 keyboard as well (Transpose function is available).

Also, if the data has not been correctly entered with the external keyboard, do the calibration as follows on the next page.



www.oldschool-sound.com

!!!!!! An exclusive free release !!!!!!

SCAN by :: JC :: neko201@free.fr :: PRAJNA rocks !
Free manuals for Free Vintage addicts ! Creative use only

\$\$\$ Not For Resale \$\$\$

(Le bizness de ressources est un sport de ptizis :)

Connections

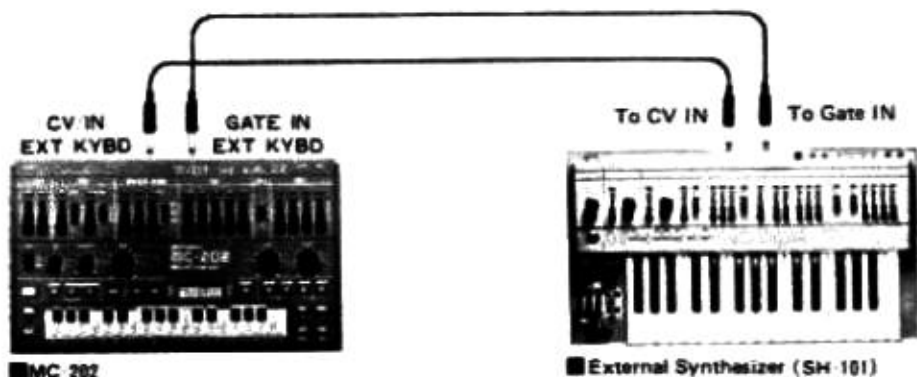

Ⓢ Please use Synthesizer with 1V/Oct CV and Positive Gate Pulse (when on : +5 to 15 V).

Cautions

Make sure that the Transpose knob on the external keyboard is set to the Normal position (8'), if entering or playing the data in normal pitch.

If you are entering data by playing the keyboard during the first two measures (while you hear a beep sound), the data cannot be entered.

The MC-202's memory accepts the CV of 0 to 5V (=61 Key keyboard). Please refer to "Sound Range Diagram P. 59".

Calibration

Use a small screwdriver for slot head screw.

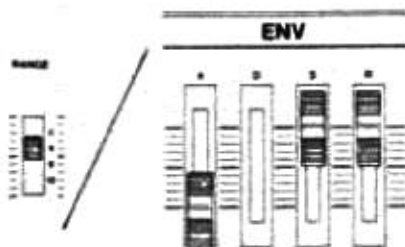

- ① Make all the necessary connections and check if playing the external keyboard sounds the MC-202's.
- ② Set the MC-202's synthesizer section as shown in the figure so that calibration will be done easily.
Set the Transpose switch on the external keyboard to the Normal position (8').

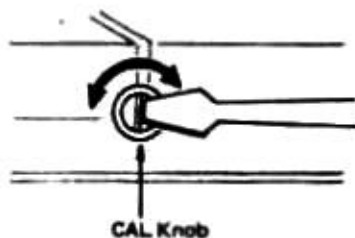

③ Start calibration.

As shown in the figure, while pressing a key, adjust the CAL knob so that the note will sound at the same pitch throughout.

Now calibration is completed.

D. Synchronizing with an external device

A 5 pin DIN cord (commercial standard) is required for the synchronization.

1 MC-202 + Sequencer

The master device turns the slave on or off and controls the Tempo.

Also, if the MC-202 is controlled by the sequencer, the MC-202's Cycle playing will be available.

MC-202 + MC-4

The MC-4 controls The MC-202

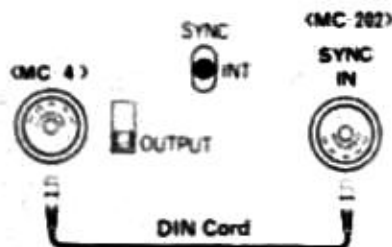

The MC-202 controls the MC-4

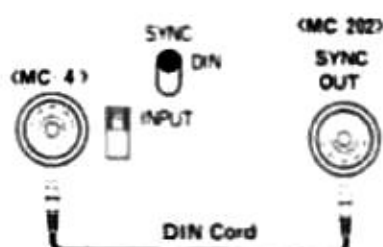

Notes

When the MC-202 is controlling the MC-4, it is possible to use the STOP/CONT key, but you have to note that the MC-202 resume from the beginning of that measure

while the MC-4 starts from the next step. Also, to start playing the data from the selected measure, you need to select it on both MC-202 and MC-4.

MC-202 + CSQ-600

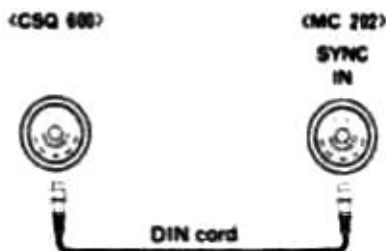

Notes

1. You cannot control the CSQ-600 by the MC-202.
2. You cannot start to play the data from the selected measure.

MC-202 + TB-303

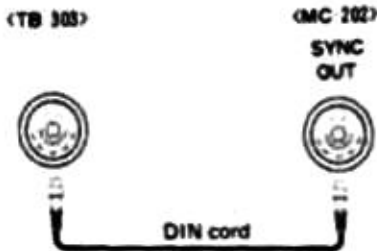

Note

You cannot control the MC-202 by the TB-303.

2 MC-202 + Rhythm Machine

The master device turns the slave on or off and controls the Tempo.

Also, if the MC-202 is controlled by the Rhythm machine, the MC-202's Cycle playing will be available.

MC-202 + TR-808, 606, CR-8000

The MC-202 Controls the rhythm machine

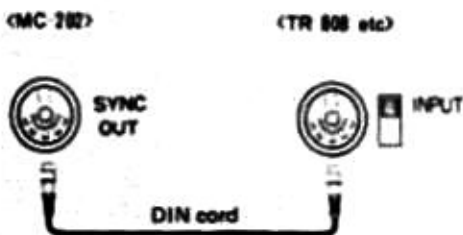

The rhythm machine Controls the MC-202

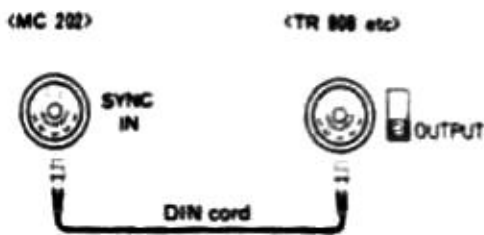

3 Multiple set up

The MC-202 can control up to 2 external devices. (A)

Also, MC-202 can be simultaneously synchronized with up to 3 devices. (B)

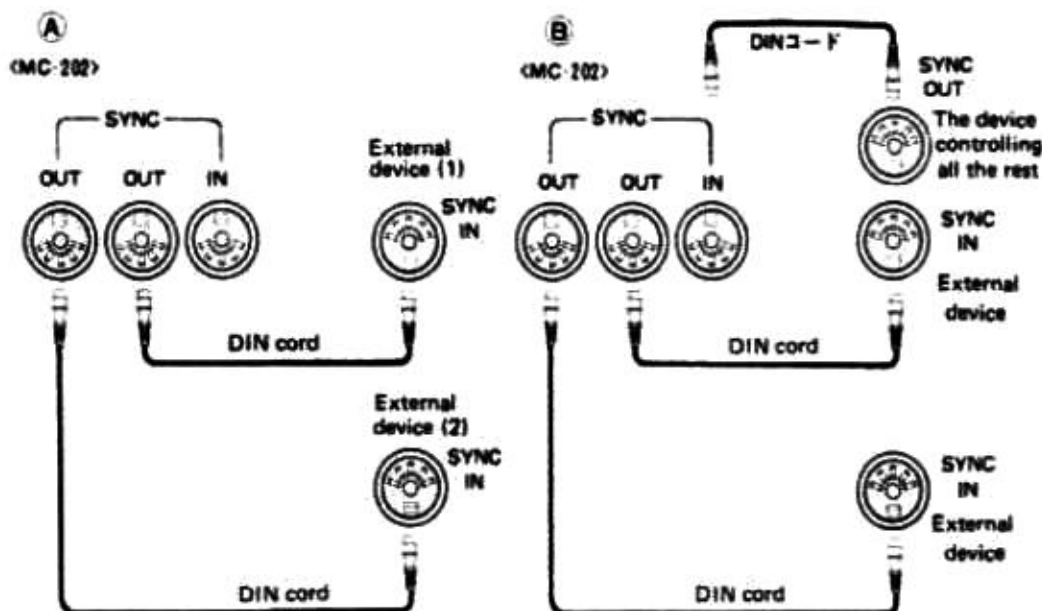

4 MC-202 + MC-202

The synchronization of more than 2 MC-202's is possible.

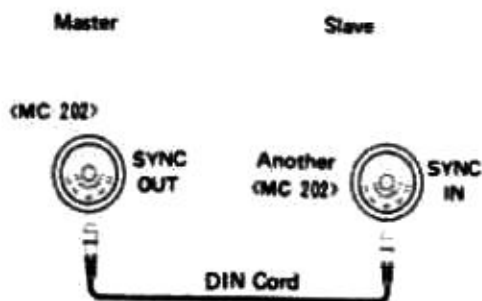

E. Tape Sync(Multi-Track Recording)

If recording the synchro signal (for tape sync) together with the MC-202's data playing, you can later overdub a track of another data just by synchronizing it with that signal.

Multi-track recording procedure by using Tape-sync function

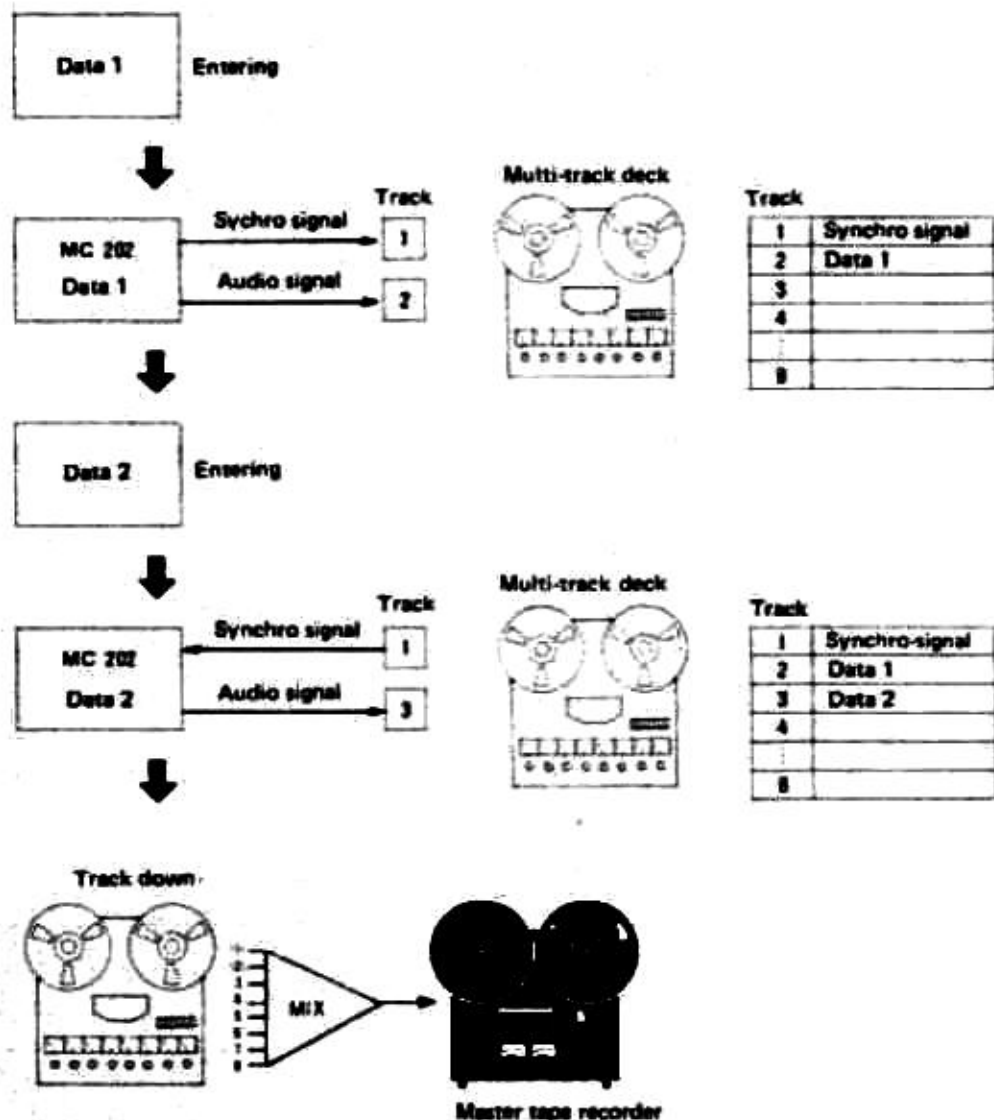

How to set up

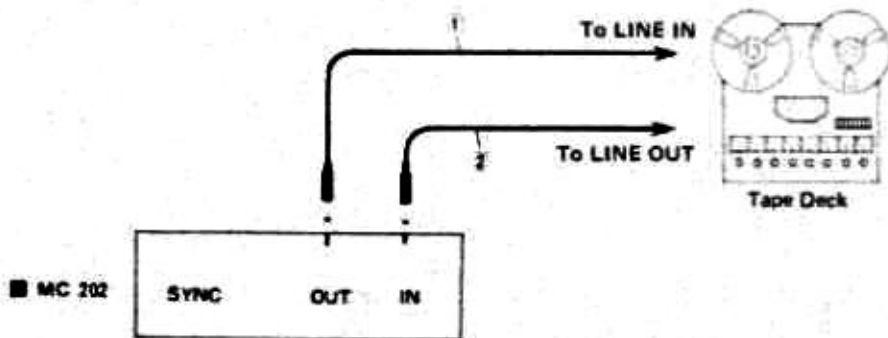

- If you wish to record the data together with the Synchro signal, connect the MC-202 output to the LINE IN (not the track the Synchro signal is recorded).

- If you wish to record only the Synchro signal, connection 2) is not necessary. Likewise, if only Synchro signal, connection 1) is not necessary.

How to record the synchro signal

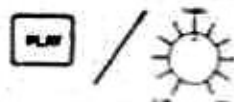

REC VOLUME



- 1 Set the MC-202 to the Play mode and adjust the TEMPO while listening to the data playing.

- 2 Stop play.

- 3 Set the tape recorder to the Recording mode, then press its PAUSE button, and set the recording level of the Pilot tone (from the MC-202) to about -10 to -3VU^* .

- You may set it to the minimum level that can run the MC-202, because the cross-talk between the channels (influence to the next recording track) should be low.

- 4 Set the tape recorder to the Recording mode, then start the MC-202 in 5 to 10 seconds.

As soon as the data playing starts, the Pilot tone will turn to the synchro signal.

- 5 If you need to change the tempo in the middle of the playing (ritardando, etc.), adjust with the Tempo knob.



- Stop the tape recorder if the data playing on the MC-202 stops.

Now you have recorded the synchro signal.

How to play the data with the Synchro signal (Multi-Track Recording)



- Set to the Play mode.

- Set the tape recorder to the Playing mode after adjusting its output level.

Make sure to start the tape before you hear the Synchro signal (while you still hear the Pilot tone).

Please complete the following procedures while you still hear the Pilot tone.



- Set to the Synchro Play mode.

- The data playing will start as soon as the Pilot tone changes to the Synchro signal.

- If the MC-202 finishes playing the data, stop the tape recorder.

Now synchro play is complete.



If the synchro signal stops, the data playing stops, too. If the Cycle function is on, the MC-202 will repeat playing the data as long as the synchro signal is coming in.

Also, it is possible to start the data playing from the middle of the synchro signal. To do this, take the procedures 3 and 4 at any place you like.

Memo

Please note that the SYNC IN jack on the rear panel should not be plugged in. (You can use the SYNC OUT jack for the synchronization, though.)



www.oldschool-sound.com

!!!!!!! An exclusive free release !!!!!!!

**SCAN by ::: JC ::: neko201@free.fr ::: PRAJNA rocks !
Free manuals for Free Vintage addicts ! Creative use only**

\$\$\$ Not For Resale \$\$\$

(: Le bizness de ressources est un sport de ptizisis :)

Sound Range Diagram

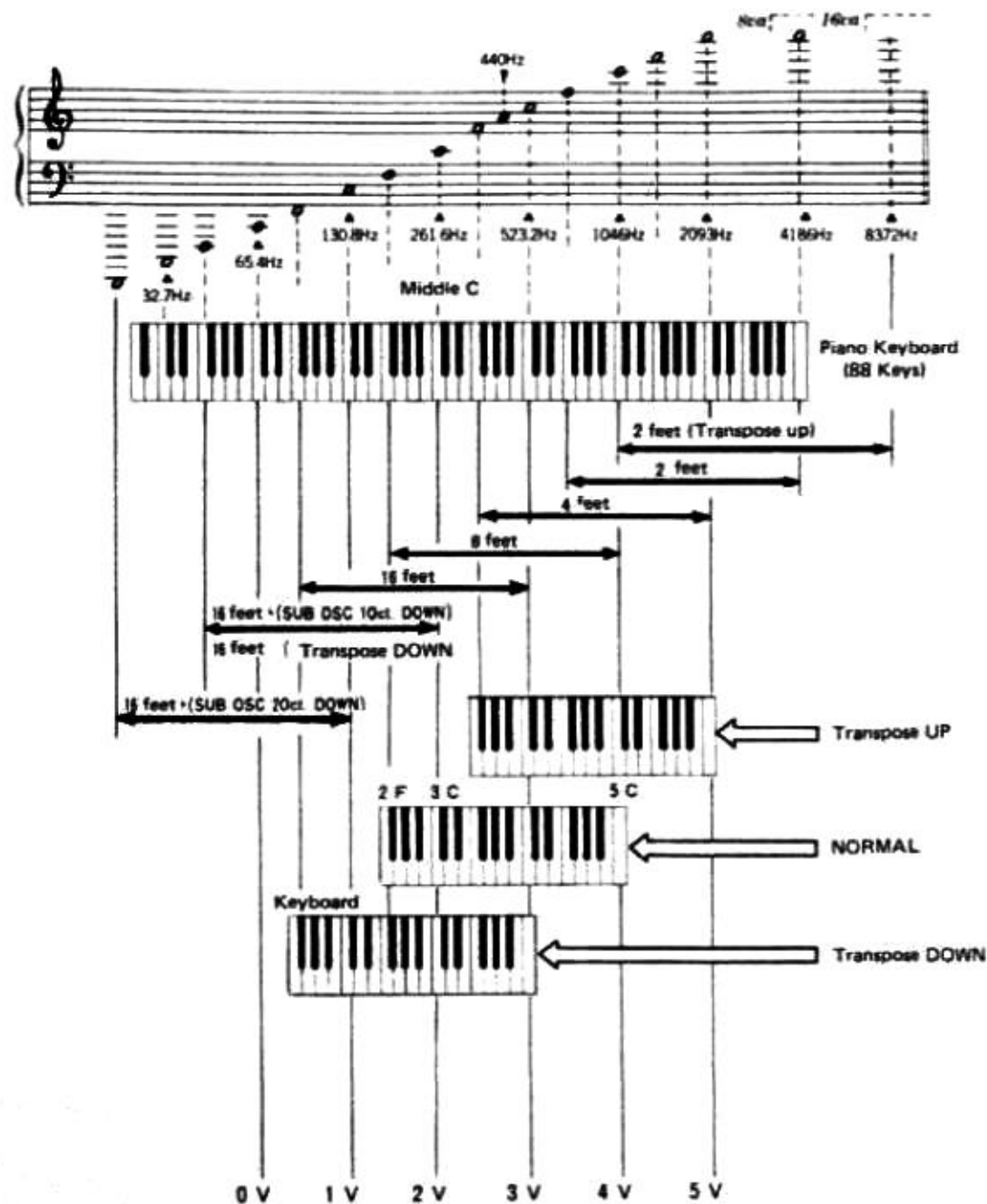

In case of trouble

If your MC-202 does not function properly, check the table below before asking for repairs.

Symptom	Possible cause
The MC-202 does not work at all even though switched on.	<ul style="list-style-type: none">• The AC adaptor is not securely connected.• The battery is dead.
There is no sound coming from the MC-202.	<ul style="list-style-type: none">• The volume of the MC-202 (and the amplifier) is set too low.• The amplifier is not securely connected to the MC-202's output.• There is something wrong with the connection cord.• The setting of the synthesizer section is not appropriate.• Only rests have been entered.• You have selected the channel in which no data is entered.
The MC-202 does not play the data.	<ul style="list-style-type: none">• There is no data entered• The MC-202 is not set to the Play mode.• The Power save function is set to on.• The DIN cord is connected to the SYNC IN jack.
The data is not correctly played.	<ul style="list-style-type: none">• Refer to "How to correct the data" on (P. 30).
You cannot write the data.	<ul style="list-style-type: none">• The MC-202 is not set to the Edit Mode.• You have already used up the maximum capacity of MC-202's memory.• The Power save function is turned on.
Synchronization is not possible.	<ul style="list-style-type: none">• The data is not correctly entered.• The DIN cord is not securely connected.• The connection of the DIN connectors for synchronization is inverted.

SPECIFICATIONS

MC-202 Micro Composer

Micro Composer Section

Memory Capacity

Approx. 2600 steps

Output

External CV output

If the MC 202's Keyboard is in use:

416. 5mV to 5V, 44 steps

If the External Keyboard is in use: 0

to 5V, 49 steps (83.3mV/step) 1

External Gate output (when OFF: 0V,

ON: 12V)

Built-In CV output : 1

Built-In Gate output : 1

Input (Keyboard Input)

CV IN (0V to 5V) : 1

GATE IN (turned on with over +3V) : 1

Calibration Trimmer : 1

Tape Interface

MEMORY SAVE (TAPE SYNC

OUT) : 1

MEMORY LOAD (TAPE SYNC IN) : 1

DIN Sync

DIN Socket IN : 1

OUT : 2

Tempo

Tempo knob (♩ = 40 to 300) : 1

Display, etc.

Liquid Crystal Display : 1

Indicator : 1

Synthesizer Section

Keyboard

32 Key, F scale

VCO

Range (16', 8', 4')

Pulse Width Modulation (50% to Min.)

PWM Selector switch (ENV/MAN/LFO)

Modulation Depth

Tune (±100 cent)

Source Mixer

↺ Level

↗ Level

Sub Oscillator Level

Sub Oscillator Waveforms

(1 Oct Down ↺, 2 Oct Down ↺,

2 Oct Down ↻)

VCF

Cutoff Frequency (10 Hz to 20 kHz)

Resonance (0 to Self Oscillation)

ENV Depth

Modulation Depth

Keyboard Follows (0 to 100%)

VCA

Control Signal Selector switch (ENV ↺ /

GATE ↻)

ENV

Attack Time (2ms to 1.5s)

Decay Time (2ms to 5s)

Sustain Level (0 to 100%)

Release Time (1ms to 5s)

LFO

LFO Rate (0.1 Hz to 30 Hz)

LFO Rate Indicator

Decay Time (0 to 1s)

PORTAMENTO

Portamento Time (0 to 2s)

ACCENT

VOLUME

Connection jacks

Output (0 dBm max.)

Headphones (Stereo 8Ω to 150Ω)

DC Input (9V to 12V AC Adaptor

PSA-120, 220 or 240)

Power switch

Power

DC 9V (C cell x 6 or PSA-120, 220 or

240)

Consumption

800mW

Dimensions

343(W) x 55(H) x 204(D) mm.

13-1/2(W) x 2-3/16(H) x 8(D) in.

Weights (batteries included)

1.35 kg (3 lb.)

Accessories

2.5m connection cable PJ-1 x 1

Sample Tape (for demonstration) x 1

C cell Batteries (BR-2) x 6

Operation Manual for the x 1

MC-202 Synthesizer

www.oldschool-sound.com

!!!!!! An exclusive free release !!!!!!

SCAN by ::: JC ::: neko201@free.fr ::: PRAJNA rocks !
Free manuals for Free Vintage addicts ! Creative use only

\$\$\$ Not For Resale \$\$\$

(: Le bizness de ressources est un sport de ptizizis :)